

## Operating Instructions Air Conditioner

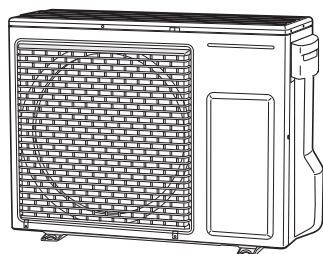

Model No.

### OUTDOOR UNIT

**Single Split (Single-phase)**

**Type PZH2**

U-36PZH2E5

U-50PZH2E5

U-60PZH2E5

**Type PZ2**

U-60PZ2E5

U-71PZ2E5

• **Connectable indoor unit lineup**

This booklet is the operating instructions for outdoor unit. Regarding the indoor unit, see the operating instructions supplied with the indoor unit.

### INDOOR UNIT

4-Way Cassette

4-Way Cassette 60 × 60

Wall-Mounted

Ceiling

Low Silhouette Ducted

Ducted



### ENGLISH 2 ~ 7

Before operating the unit, read these operating instructions thoroughly and keep them for future reference.

E<sub>NGLISH</sub>

### FRANÇAIS 8 ~ 13

Avant d'utiliser l'appareil, lisez ce mode d'emploi dans son intégralité et conservez-le pour toute référence ultérieure.

F<sub>RANÇAIS</sub>

### ESPAÑOL 14 ~ 19

Antes de operar la unidad, lea atentamente estas instrucciones de funcionamiento y guárdelas para futuras consultas.

E<sub>SPAÑOL</sub>

### DEUTSCH 20 ~ 25

Bevor Sie das Gerät in Betrieb nehmen, lesen Sie bitte diese Bedienungsanleitung aufmerksam durch und bewahren Sie sie für die künftige Verwendung auf.

D<sub>EUTSCH</sub>

### ITALIANO 26 ~ 31

Prima di utilizzare l'unità, leggere a fondo queste istruzioni per l'uso e conservarle come riferimento futuro.

I<sub>TALIANO</sub>

### NEDERLANDS 32 ~ 37

Lees deze gebruiksinstructies goed door voor u het apparaat gebruikt en bewaar ze voor toekomstig gebruik.

N<sub>EDERLANDS</sub>

### PORTUGUÊS 38 ~ 43

Antes de utilizar o aparelho, leia completamente este manual de instruções e guarde-o para futuras referências.

P<sub>ORTUGUÊS</sub>

### ΕΛΛΗΝΙΚΑ 44 ~ 49

Πριν θέσετε τη μονάδα σε λειτουργία, διαβάστε πολύ καλά αυτές τις οδηγίες χρήσης και διατηρήστε τις για μελλοντική αναφορά.

E<sub>ΛΛΗΝΙΚΑ</sub>

### БЪЛГАРСКИ 50 ~ 55

Преди да започнете експлоатация на този уред, прочетете внимателно тези инструкции и ги запазете, за да можете да правите справки с тях и в бъдеще.

B<sub>ЪЛГАРСКИ</sub>

### TÜRKÇE 56 ~ 61

Üniteyi çalıştırmadan önce bu çalıştırma talimatlarını iyice okuyun ve gelecekte başvurmak için saklayın.

T<sub>ÜRKÇE</sub>



Thank you for purchasing this Panasonic product.  
 This product is a commercial air conditioner indoor unit.  
 Installation Instructions attached.

# Contents

- Safety Precautions ..... 2
- Precautions for Use ..... 5
- Names of Parts ..... 6

---

- Specifications ..... 62
  - Outdoor unit ..... 62
  - Corresponding language table ..... 62

	<b>WARNING</b>	This symbol shows that this equipment uses a flammable refrigerant. If the refrigerant is leaked, together with an external ignition source, there is a possibility of ignition.
	<b>CAUTION</b>	This symbol shows that a service personnel should be handling this equipment with reference to the Technical Manual.
	<b>CAUTION</b>	This symbol shows that there is information included in the Operating Instructions and/or Installation Instructions.

## Product Information

If you have problems or questions concerning your Air Conditioner, you will need the following information. Model and serial numbers are on the nameplate.

Model No. \_\_\_\_\_

Serial No. \_\_\_\_\_

Date of purchase \_\_\_\_\_

Dealer's address \_\_\_\_\_

Phone number \_\_\_\_\_

### Important Information Regarding The Refrigerant Used

This product contains fluorinated greenhouse gases. Do not vent gases into the atmosphere.

Refrigerant type: R32



GWP<sup>(1)</sup> value: 675

<sup>(1)</sup>GWP = global warming potential

Periodical inspections for refrigerant leaks may be required depending on European or local legislation. Please contact your local dealer for more information.

# Safety Precautions

The following symbols used in this manual, alert you to potentially dangerous conditions to users, service personnel or the appliance:

	<b>WARNING</b>	This symbol refers to a hazard or unsafe practice which can result in severe personal injury or death.
	<b>CAUTION</b>	This symbol refers to a hazard or unsafe practice which can result in personal injury or product or property damage.

	Prohibited matters		Matters to be observed
---	--------------------	---	------------------------

- Read these Operating Instructions carefully before using this air conditioner. If you still have any difficulties or problems, consult your dealer for help.
- This air conditioner is designed to give you comfortable room conditions. Use this only for its intended purpose as described in these Operating Instructions.

## ! WARNING



Confirm to authorized dealer or specialist on usage of specified refrigerant type. Using of refrigerant other than the specified type may cause product damage, burst and injury etc.

---

This air conditioner has no ventilator for intaking fresh air from outdoors. You must open doors or windows frequently when you use gas or oil heating appliances in the same room, which consume a lot of oxygen from the air. Otherwise there is a risk of suffocation in an extreme case.



Never use or store gasoline or other flammable vapor or liquid near the air conditioner — it is very dangerous.

---

Do not use this appliance in a potentially explosive atmosphere.

Never touch the unit with wet hands.

---

Do not insert your fingers or other objects into the air conditioner indoor or outdoor unit, rotating parts may cause injury. 

## WARNING



If the refrigerant comes in contact with a flame, it produces a toxic gas.

For safety, be sure to turn the air conditioner off and also to disconnect the power before cleaning or servicing.

Pull off the power plug from a receptacle, or switch off the breaker, or switch off the power disconnecting mean to isolate the air conditioner from the main power supply in case of emergency.



Dispose of according to national and/or local legislation.



This product must not be modified or disassembled under any circumstances.

Modified or disassembled unit may cause fire, electric shock or injury.

Do not clean inside the indoor and outdoor units by users. Engage authorized dealer or specialist for cleaning.

In case of malfunction of this appliance, do not repair by yourself. Contact to the sales dealer or service dealer for a repair and disposal.



Provide a power outlet to be used exclusively for each unit, and a power supply disconnect, Earth Leakage Circuit Breaker (ELCB) or Residual Current Device (RCD) for overcurrent protection should be provided in the exclusive line.

Provide a power outlet exclusively for each unit, and full disconnection means having a contact separation in all poles must be incorporated in the fixed wiring in accordance with the wiring rules.

To prevent possible hazards from insulation failure, the unit must be grounded.



Do not use modified cord, joint cord, extension cord or unspecified cord to prevent overheating and fire.



The appliance shall be stored in a room without continuously operating ignition sources (for example: open flames, an operating gas appliance or an operating electric heater).

Be aware that refrigerants may not contain an odour.

An unventilated area where the appliance using flammable refrigerants is installed shall be so constructed that should any refrigerant leak, it will not stagnate so as to create a fire or explosion hazard.

The appliance shall be stored in a well-ventilated area where the room size corresponds to the room area as specified for operation.

After the unit is installed, never fail to ask the installer for the floor space of the room where the unit is installed and the refrigerant charge amount.

In case the unit or the room divider is changed, never fail to consult the sales dealer or service dealer.





Do not use means to accelerate the defrosting process or to clean, other than those recommended by the manufacturer.

Do not pierce or burn.

In cases that require mechanical ventilation, ventilation openings shall be kept clear of obstruction.



## WARNING

 The appliance shall be stored in a room without continuously operating open flames (for example: an operating gas appliance) and ignition sources (for example: an operating electric heater).

 Stop using the product when any abnormality/failure occurs and disconnect the power plug or turn off the power switch and breaker. (Risk of smoke/fire/electric shock)  
Examples of abnormality/failure:

- The ELCB trips frequently.
- The product sometimes does not start when turned on.
- The power is sometimes disconnected when the cord is moved.
- Burnt odor or abnormal noise is detected during operation.
- The body is deformed or abnormally hot.
- Water leaks from the indoor unit.
- Power cord or plug becomes abnormally hot.
- Fan speed cannot be controlled.
- The unit stops running immediately even if it is switched on for operation.
- The fan does not stop even if the operation is stopped.

Contact immediately your local dealer for maintenance/repair.

 Do not sit or step on the unit.  You may fall down accidentally.

## CAUTION

 This appliance is intended to be used by expert or trained users in shops, in light industry and on farms, or for commercial use by lay persons.

This appliance can be used by children aged from 8 years and above and persons with reduced physical, sensory or mental capabilities or lack of experience and knowledge if they have been given supervision or instruction concerning use of the appliance in a safe way and understand the hazards involved. Children shall not play with the appliance. Cleaning and user maintenance shall not be made by children without supervision.

Keep the fire alarm and the air outlet at least 1.5m away from the unit.

Do not cool or heat the room too much if babies or invalids are present.

 Do not turn the air conditioner on and off from the power mains switch. Use the ON/OFF operation button.

Do not stick anything into the air outlet of the outdoor unit. This is dangerous because the fan is rotating at high speed.



Do not touch the air inlet or the sharp aluminum fins of the outdoor unit. You may get injured.



Do not stick any object into the FAN CASE. You may be injured and the unit may be damaged.



## NOTICE

- The appliance shall be stored so as to prevent mechanical damage from occurring.
- The compressor may occasionally stop during thunderstorms. This is not a mechanical failure. The unit automatically recovers after a few minutes.
- The English text is the original instructions. Other languages are translation of the original instructions.

# Precautions for Use

## Installation

- This air conditioner must be installed properly by qualified installation technicians in accordance with the Installation Instructions provided with the unit.
- Before installation, check that the voltage of the electric supply in your home or office is the same as the voltage shown on the nameplate.



## WARNING

### Avoid the following locations for installation.

- Locations where smoke or combustible gas exists. Also locations of extremely high temperature such as a greenhouse.
- Locations where excessively high heat-generating objects are placed.

### Attention:

- Avoid installing the outdoor unit where salty sea water can splash directly onto it or in sulphurous air near a spa. (To protect the air conditioner from heavy corrosion)

## Wiring

- All wiring must conform to the local electrical codes. (Consult your dealer or a qualified electrician for details.)
- Each unit must be properly grounded with a ground (or earth) wire or through the supply wiring.
- Wiring must be done by a qualified electrician.

## Operation Preparation

### Turn the power mains on 5 hours before the start of operation.

(For warm-up)

- Leave the power mains ON for continuous use.



### NOTE

Pull off the power plug from a receptacle, or switch off the breaker, or switch off the power disconnecting mean to isolate the air conditioner from the main power supply when not in use for a long time.

### Information for Users on Collection and Disposal of Old Equipment and Used Batteries



These symbols on the products, packaging, and/or accompanying documents mean that used electrical and electronic products and batteries should not be mixed with general household waste.

For proper treatment, recovery and recycling of old products and used batteries, please take them to applicable collection points, in accordance with your national legislation and the Directives 2002/96/EC and 2006/66/EC. By disposing of these products and batteries correctly, you will help to save valuable resources and prevent any potential negative effects on human health and the environment which could otherwise arise from inappropriate waste handling.

For more information about collection and recycling of old products and batteries, please contact your local municipality, your waste disposal service or the point of sale where you purchased the items.

Penalties may be applicable for incorrect disposal of this waste, in accordance with national legislation.

### For business users in the European Union

If you wish to discard electrical and electronic equipment, please contact your dealer or supplier for further information.

### [Information on Disposal in other Countries outside the European Union]

These symbols are only valid in the European Union. If you wish to discard these items, please contact your local authorities or dealer and ask for the correct method of disposal.



### Note for the battery symbol (bottom two symbol examples):

This symbol might be used in combination with a chemical symbol. In this case it complies with the requirement set by the Directive for the chemical involved.



# Names of Parts

## OUTDOOR UNIT

### Single Split

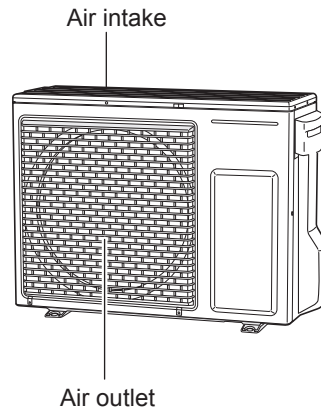

## Optional

### Wireless Remote Controller

Model No.  
CZ-RWS3



(Infrared Remote  
Controller)

Model No.  
CZ-RWSK2



### Timer Remote Controller



Model No.  
CZ-RTC4

For all indoor  
units

### High-spec Wired Remote Controller



Model No.  
CZ-RTC5B

For all indoor  
units

Read the Operating Instructions included with the Remote Controller.

### ■ Operation

Refer to the Operating Instructions attached to the optional Remote Controller.

### ■ Adjusting Airflow Direction

Refer to the Operating Instructions attached to the indoor unit and optional Remote Controller.

### ■ Maintenance







Refer to the Operating Instructions attached to the indoor unit.

### ■ Troubleshooting

Refer to the Operating Instructions attached to the indoor unit.

## Markings for Directive 2014/68/EU (PED)

Rating nameplate figure

<b>Panasonic</b>			<b>CE</b> 0035
Air Conditioner		<b>Model No.</b> A: Model Name Various	
POWER SOURCE : B: Various			
MAX ELECTRIC INPUT C: kW A			
TIME DELAY FUSE MAX SIZE : D: A			
UNIT PROTECTION : IPX4			
Operating Spec. Area Various (Not for the PED)			
MAX.WORKING PRESSURE : HIGH SIDE E: bar ( MPa) Various LOW SIDE F: bar ( MPa) Various			
REFRIGERANT : R32 G: kg Various			
NET WEIGHT: Various (Not for the PED)			
SERIAL NO. : Various		PROD. DATE : YYYY.MM	
THE CAPACITY, CURRENT AND POWER INPUT ARE FOR THIS UNIT CONNECTED TO THE FOLLOWING INDOOR UNITS. Various (Not for the PED) FOR OTHER COMBINATIONS, REFER TO MANUAL.			
Authorized representative in EU Panasonic Testing Centre		Panasonic Marketing Europe GmbH Winsbergring 15, 22525 Hamburg, Germany	
Panasonic Corporation 1006 Kadoma, Kadoma City, Osaka, Japan			Made in Malaysia
<b>R32</b>    			
 THIS PRODUCT CONTAINS FLUORINATED GREENHOUSE GASES R 3 2 GWP=6 7 5			
Various			

### Tabulation of Various data

A	U-36PZH2E5	U-50PZH2E5	U-60PZH2E5
B	220 - 230 - 240 V~ 50 Hz		
C	2.40 kW, 11.0 A	2.68 kW, 12.0 A	3.54 kW, 16.4 A
D	20 A	20 A	25 A
E	41.5 bar (4.15 MPa)		
F	27.0 bar (2.70 MPa)		
G	1.15 kg	1.15 kg	1.45 kg

A	U-60PZ2E5	U-71PZ2E5
B	220 - 230 - 240 V~ 50 Hz	
C	3.54 kW, 16.4 A	3.54 kW, 16.4 A
D	25 A	25 A
E	41.5 bar (4.15 MPa)	
F	25.5 bar (2.55 MPa)	
G	1.45 kg	1.45 kg



Nous vous remercions d'avoir fait l'acquisition de ce produit Panasonic.  
Ce produit est une unité intérieure de climatiseur commercial.  
Instructions d'installation jointes.

# Table des matières

- Précautions de sécurité ..... 8
- Précautions d'utilisation ..... 11
- Nom des pièces ..... 12

---

- Caractéristiques ..... 62
  - Unité extérieure ..... 62
  - Tableau des langues correspondantes ..... 62

	<b>AVERTISSEMENT</b>	Ce symbole indique que cet équipement utilise un réfrigérant inflammable. En présence d'une source d'inflammation externe, une fuite de réfrigérant peut provoquer une inflammation.
	<b>PRÉCAUTION</b>	Ce symbole indique que l'équipement doit être manipulé par un technicien après-vente, qui se reportera au Manuel technique.
	<b>PRÉCAUTION</b>	Ce symbole indique que des informations sont incluses dans le mode d'emploi et/ou les Instructions d'installation.

## Informations sur le produit

Pour tout problème ou toute question relatifs au climatiseur, les informations ci-dessous sont requises. Les numéros de modèle et de série se trouvent sur la plaque signalétique.

No. de modèle	
No. de série	
Date d'achat	
Adresse du revendeur	
Numéro de téléphone	

### Informations importantes concernant le réfrigérant utilisé

Ce produit contient des gaz à effet de serre fluorés. N'évacuez pas des gaz dans l'atmosphère.

Type de réfrigérant: R32



Valeur GWP<sup>(1)</sup> : 675

<sup>(1)</sup>GWP = global warming potential (Potentiel de Réchauffement Global)

Des vérifications périodiques d'absence de fuites peuvent être nécessaires en fonction de la législation européenne ou locale. Contactez votre revendeur local pour plus d'informations.

# Précautions de sécurité

Les symboles suivants utilisés dans ce mode d'emploi avertissent d'un danger potentiel pour l'utilisateur, le personnel d'entretien ou l'appareil :

	<b>AVERTISSEMENT</b>	Ce symbole signale un danger ou des opérations dangereuses qui risquent d'entraîner des blessures physiques graves ou mortelles.
	<b>PRÉCAUTION</b>	Ce symbole signale un danger ou des opérations dangereuses qui risquent d'entraîner des blessures physiques ou des dommages matériels, notamment de l'appareil.

	Actions interdites		Points à observer
---	--------------------	---	-------------------

- Lire attentivement ce mode d'emploi avant de faire fonctionner le climatiseur. Si l'on rencontre des difficultés ou des problèmes, consulter le revendeur.
- Le climatiseur est conçu pour créer un environnement confortable chez soi. Ne l'utiliser qu'aux fins pour lesquelles il a été prévu, en suivant les instructions de ce mode d'emploi.

## ⚠ AVERTISSEMENT



S'informer auprès d'un revendeur agréé ou d'un spécialiste concernant l'utilisation du type de réfrigérant spécifié. L'utilisation d'un type de réfrigérant autre que celui spécifié comporte un risque d'endommagement du produit, d'éclatement et de blessure, etc.

---

Le climatiseur ne possède pas de ventilateur d'admission d'air frais extérieur. Il faudra donc ouvrir fréquemment les portes ou les fenêtres si l'on utilise dans la même pièce des appareils de chauffage à gaz ou au mazout qui consomment beaucoup d'oxygène. Sinon, il y aurait risque d'asphyxie dans les cas extrêmes.

---



Ne jamais utiliser ni entreposer d'essence ni aucune autre vapeur ou liquides inflammables près du climatiseur — cela serait extrêmement dangereux.

---

Ne pas utiliser cet appareil dans une atmosphère potentiellement explosive.

---

Ne jamais toucher l'unité avec des mains humides.

---



Ne pas insérer les doigts ni d'autres objets dans l'unité intérieure ou extérieure du climatiseur, car les pièces rotatives présentent un risque de blessure.



## AVERTISSEMENT

 Le contact du réfrigérant avec une flamme peut produire un gaz toxique.

Par mesure de sécurité, éteindre le climatiseur et le débrancher aussi de la prise secteur avant son nettoyage ou entretien.

Débrancher la prise d'alimentation de la prise secteur, ou désactiver le disjoncteur ou désactiver le dispositif de déconnexion de l'alimentation afin d'isoler le climatiseur de l'alimentation principale en cas d'urgence. 

Mettez au rebut conformément aux lois nationales et/ou locales.

 Ce produit ne doit en aucune circonstance être modifié ou démonté. Une unité modifiée ou démontée peut provoquer un incendie, une électrocution ou des blessures.



Les utilisateurs ne doivent pas nettoyer l'intérieur des unités intérieures et extérieures. Faire appel à un revendeur agréé ou à un spécialiste pour le nettoyage.

En cas de dysfonctionnement de cet appareil, ne pas le réparer soi-même. Prenez contact avec le revendeur ou un SAV pour la réparation et la mise au rebut.

 Prévoyez une prise électrique à utiliser exclusivement pour chaque unité, et prévoyez un dispositif de déconnexion de l'alimentation, un disjoncteur de fuite à la terre ou un disjoncteur différentiel pour la protection contre surintensité de courant dans la ligne exclusive.

Prévoir une prise secteur électrique exclusive pour chaque unité, et un moyen de déconnexion totale de l'alimentation ayant une séparation de contact sur tous les pôles doit être incorporé au câblage fixe conformément aux normes de câblage.

Pour éviter les risques possibles d'une défaillance d'isolation, l'unité doit être mise à la terre. 

 Ne pas utiliser de cordon, de rallonge ou de cordon non spécifié afin d'éviter tout risque de surchauffe et d'incendie.  

 L'appareil doit être stocké dans une pièce sans sources d'allumage utilisées en continu (par exemple, flammes nues, appareil à gaz en marche ou chauffage électrique en marche).

Attention, certains réfrigérants ne contiennent pas d'agent odorant.

Si l'appareil utilisant des réfrigérants inflammables est installé dans une zone non ventilée, celle-ci doit être agencée de manière à ce que les éventuelles fuites de réfrigérant ne stagnent pas pour ne pas entraîner de risque d'incendie ou d'explosion.

L'appareil doit être stocké dans un endroit bien ventilé, dans une pièce d'une superficie correspondant à celle spécifiée pour l'utilisation.

Après avoir installé l'unité, demandez impérativement à l'installateur l'espace au sol de la pièce où l'unité est installée et la quantité de charge du réfrigérant.

En cas de changement d'unité ou de cloison de séparation, consultez impérativement le revendeur ou le dépanneur.

 N'utiliser aucun dispositif autre que ceux recommandés par le fabricant pour accélérer le processus de dégivrage.

Ne pas percer ni brûler.

Si une ventilation mécanique est nécessaire, les événements ne doivent pas être obstrués.



## AVERTISSEMENT

 L'appareil doit être stocké dans une pièce exempte de flammes nues continues (par exemple, un appareil à gaz en marche) et de sources de chaleur (par exemple, un radiateur électrique en marche).

 Cesser d'utiliser le produit lorsqu'une anomalie ou défaillance quelconque se produit et débrancher la fiche d'alimentation ou mettre hors tension l'interrupteur et le disjoncteur. (Risque de fumée/incendie/décharge électrique)  
Exemples d'anomalie ou défaillance :

- L'ELCB se déclenche fréquemment.
- Le produit ne se met parfois pas en marche lorsqu'il est mis sous tension.
- L'alimentation est parfois déconnectée lorsque le cordon est bougé.
- Une odeur de brûlé ou un bruit anormal est détecté pendant le fonctionnement.
- Le corps est déformé ou anormalement chaud.
- Fuite d'eau de l'unité intérieure.
- Le cordon d'alimentation ou la prise deviennent anormalement chauds.
- La vitesse du ventilateur ne peut pas être contrôlée.
- L'unité s'arrête de fonctionner immédiatement même si elle est activée pour opérer.
- Le ventilateur ne s'arrête pas même si l'opération est arrêtée.

Contactez immédiatement le revendeur local pour un entretien/réparation.

 Ne pas s'asseoir ou monter sur l'unité.  Il y a un risque de chute accidentelle.

## NOTIFICATION

- L'appareil doit être stocké de manière à éviter tout dommage mécanique.
- Il se peut que le compresseur s'arrête parfois pendant des orages. Ceci n'est pas une panne mécanique. L'appareil redémarre automatiquement après quelques minutes.
- Le texte anglais correspond aux instructions d'origine. Les autres langues sont les traductions des instructions d'origine.

## PRÉCAUTION

 Cet appareil est conçu pour être utilisé par des utilisateurs expérimentés ou confirmés en magasin, dans l'industrie légère et dans les fermes, ou pour une utilisation commerciale par les profanes.

Cet appareil peut être utilisé par des enfants à partir de 8 ans et des personnes aux facultés physiques, sensorielles ou mentales diminuées ou sans expérience ni expertise sous la surveillance d'un adulte ou s'ils ont reçu des instructions concernant l'utilisation sécuritaire de l'appareil et s'ils comprennent les risques encourus. Les enfants ne doivent pas jouer avec l'appareil. Le nettoyage et la maintenance utilisateur ne doivent pas être effectués par un enfant laissé sans surveillance.



Placer l'alarme incendie et la sortie d'air à au moins 1,5 m de l'unité.

Ne pas trop refroidir ou chauffer une pièce où se trouvent des bébés ou des malades.

 Ne pas mettre le climatiseur sous et hors tension à l'aide de l'interrupteur d'alimentation du système. Utiliser le bouton de marche/arrêt de fonctionnement (ON/OFF).

Ne rien introduire dans la sortie d'air de l'unité extérieure. Cela est très dangereux, car le ventilateur marche à grande vitesse. 

Ne pas toucher l'arrivée d'air ou les ailettes coupantes en aluminium de l'unité extérieure. Il y a un risque de blessure. 

Ne pas introduire d'objet dans le BOITIER DU VENTILATEUR. Il y a un risque de blessure et l'unité pourrait être endommagée.  

# Précautions d'utilisation

## Installation

- Ce climatiseur doit être installé par un technicien qualifié et conformément aux instructions fournies avec l'appareil.
- Avant de procéder à l'installation, vérifier que la tension secteur du local d'utilisation (bureau ou habitation) est la même que celle indiquée sur la plaque signalétique.

## AVERTISSEMENT

### Éviter les endroits suivants pour l'installation.

- Endroits où de la fumée ou des gaz inflammables sont présents. Endroits à la température extrêmement élevée, comme une serre.
- Endroits où sont placés des objets générant une chaleur excessivement élevée.

### Attention :

- Éviter d'installer l'unité extérieure dans un endroit qui risque d'être aspergé d'eau de mer ou dans un environnement sulfureux, par exemple à proximité d'une source thermique. (Pour protéger le climatiseur de toute corrosion)

## Câblage

- Tous les câbles doivent respecter les codes électriques locaux. (Pour les détails, consulter le revendeur ou un électricien qualifié.)
- Chaque unité doit être correctement mise à la terre avec un fil de terre (ou de masse) ou au moyen d'un câblage d'alimentation.
- Les raccordements devront être confiés à un électricien qualifié.

## Préparatifs de fonctionnement

### Mettre le climatiseur sous tension 5 heures environ avant de le faire fonctionner.

(pour le chauffer)

- Le laisser sous tension pour un usage continu.

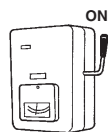

### REMARQUE

Débrancher la prise d'alimentation de la prise secteur, ou désactiver le disjoncteur ou désactiver le dispositif de déconnexion de l'alimentation afin d'isoler le climatiseur de l'alimentation principale lorsqu'il n'est pas utilisé pendant longtemps.

### Avis aux utilisateurs concernant la collecte et l'élimination des piles et des appareils électriques et électroniques usagés



Apposé sur le produit lui-même, sur son emballage, et/ou figurant dans la documentation qui l'accompagne, ce pictogramme indique que les piles et appareils électriques et électroniques usagés doivent être séparés des ordures ménagères.

Afin de permettre le traitement, la valorisation et le recyclage adéquats des piles et des appareils usagés, veuillez les porter à l'un des points de collecte prévus, conformément à la législation nationale en vigueur ainsi qu'aux directives 2002/96/CE et 2006/66/CE.

En éliminant piles et appareils usagés conformément à la réglementation en vigueur, vous contribuez à prévenir le gaspillage de ressources précieuses ainsi qu'à protéger la santé humaine et l'environnement contre les effets potentiellement nocifs d'une manipulation inappropriée des déchets. Pour de plus amples renseignements sur la collecte et le recyclage des piles et appareils usagés, veuillez vous renseigner auprès de votre mairie, du service municipal d'enlèvement des déchets ou du point de vente où vous avez acheté les articles concernés.

Le non-respect de la réglementation relative à l'élimination des déchets est passible d'une peine d'amende.

#### Pour les utilisateurs professionnels au sein de l'Union européenne

Si vous souhaitez vous défaire de pièces d'équipement électrique ou électronique, veuillez vous renseigner directement auprès de votre détaillant ou de votre fournisseur.

#### [Information relative à l'élimination des déchets dans les pays extérieurs à l'Union européenne]

Ce pictogramme n'est valide qu'à l'intérieur de l'Union européenne. Pour connaître la procédure applicable dans les pays hors Union européenne, veuillez vous renseigner auprès des autorités locales compétentes ou de votre distributeur.



#### Note relative au pictogramme à apposer sur les piles (voir les 2 exemples ci-contre) :

Le pictogramme représentant une poubelle sur roues barrée d'une croix est conforme à la réglementation. Si ce pictogramme est combiné avec un symbole chimique, il remplit également les exigences posées par la Directive relative au produit chimique concerné.



# Nom des pièces

## UNITÉ EXTÉRIEURE

### Bi-Bloc Simple

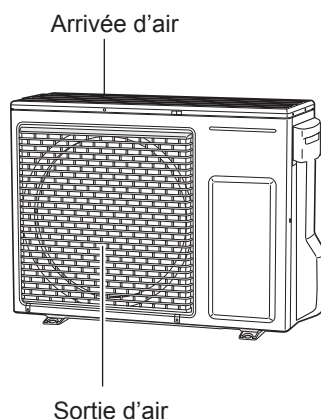

### Optionnel

#### Télécommande sans fil

No.de modèle  
CZ-RWS3



(Télécommande  
sans fil)

No.de modèle  
CZ-RWSK2



#### Télécommande de minuterie

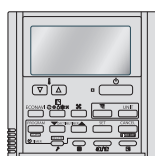

No.de modèle  
CZ-RTC4

Pour toutes les  
unités intérieures

#### Télécommande câblée haut de gamme



No.de modèle  
CZ-RTC5B

Pour toutes les  
unités intérieures

Lire le mode d'emploi accompagnant la télécommande.

#### ■ Fonctionnement

Consultez le mode d'emploi fourni avec la télécommande en option.

#### ■ Réglage de la direction du flux d'air

Consultez le mode d'emploi fourni avec l'unité intérieure et la télécommande en option.

#### ■ Maintenance





Consultez le mode d'emploi fourni avec l'unité intérieure.

#### ■ Dépannage

Consultez le mode d'emploi fourni avec l'unité intérieure.

## Repères pour la Directive 2014/68/EU (PED)

Figure de la plaque signalétique nominale

<b>Panasonic</b>			<b>CE</b> 0035
Air Conditioner		<b>Model No.</b> A: Model Name Various	
POWER SOURCE : B: Various			
MAX ELECTRIC INPUT C: kW A			
TIME DELAY FUSE MAX SIZE : D: A			
UNIT PROTECTION : IPX4			
Operating Spec. Area Various (Not for the PED)			
MAX.WORKING PRESSURE : HIGH SIDE E: bar ( MPa) Various LOW SIDE F: bar ( MPa) Various			
REFRIGERANT : R32 G: kg Various			
NET WEIGHT: Various (Not for the PED)			
SERIAL NO. : Various		PROD. DATE : YYYY.MM	
THE CAPACITY, CURRENT AND POWER INPUT ARE FOR THIS UNIT CONNECTED TO THE FOLLOWING INDOOR UNITS. Various (Not for the PED) FOR OTHER COMBINATIONS, REFER TO MANUAL.			
Authorized representative in EU Panasonic Testing Centre		Panasonic Marketing Europe GmbH Winsbergring 15, 22525 Hamburg, Germany	
Panasonic Corporation 1006 Kadoma, Kadoma City, Osaka, Japan			Made in Malaysia
<b>R32</b>    			
 THIS PRODUCT CONTAINS FLUORINATED GREENHOUSE GASES R 3 2 GWP=6 7 5			
Various			

### Tableau de données diverses

A	U-36PZH2E5	U-50PZH2E5	U-60PZH2E5
B	220 - 230 - 240 V~ 50 Hz		
C	2,40 kW, 11,0 A	2,68 kW, 12,0 A	3,54 kW, 16,4 A
D	20 A	20 A	25 A
E	41,5 bar (4,15 MPa)		
F	27,0 bar (2,70 MPa)		
G	1,15 kg	1,15 kg	1,45 kg

A	U-60PZ2E5	U-71PZ2E5
B	220 - 230 - 240 V~ 50 Hz	
C	3,54 kW, 16,4 A	3,54 kW, 16,4 A
D	25 A	25 A
E	41,5 bar (4,15 MPa)	
F	25,5 bar (2,55 MPa)	
G	1,45 kg	1,45 kg



Le agradecemos la compra de este producto Panasonic. Este dispositivo es una unidad interior de acondicionador de aire comercial. Las instrucciones de instalación se incluyen con el aparato.

# Índice

- Precauciones de seguridad ..... 14
- Precauciones de uso ..... 17
- Nombres de las partes ..... 18

---

- Especificaciones ..... 62
  - Unidad exterior ..... 62
  - Tabla de correspondencia de idiomas ..... 62

	<b>ADVERTENCIA</b>	Este símbolo indica que este equipo utiliza un refrigerante inflamable. Si se produce una fuga del refrigerante y hay presente una fuente de ignición externa, existe la posibilidad de ignición.
	<b>PRECAUCIÓN</b>	Este símbolo indica que el personal de mantenimiento debe manipular este equipo consultando el Manual técnico.
	<b>PRECAUCIÓN</b>	Este símbolo indica que hay información incluida en las instrucciones de funcionamiento o las instrucciones de instalación.

## Información del producto

Si tiene preguntas o problemas relacionados con su acondicionador de aire necesitará la siguiente información. El modelo y el número de serie se encuentran en la placa de características.

N.º de modelo	
N.º de serie	
Fecha de adquisición	
Dirección del distribuidor	
Número de teléfono	

### Información importante referente al refrigerante utilizado

Este producto contiene gases de efecto invernadero fluorados. No ventile los gases a la atmósfera.

Tipo de refrigerante: R32





GWP<sup>(1)</sup> valor: 675

<sup>(1)</sup>GWP = global warming potential (potencial de calentamiento atmosférico)

Dependiendo de la legislación local o la europea será necesario realizar inspecciones periódicas. Contacte con su proveedor local para obtener más información.

# Precauciones de seguridad

Los símbolos siguientes utilizados en estas instrucciones de funcionamiento le avisan de que existen condiciones potencialmente peligrosas para los usuarios, el personal de servicio o el propio aparato:

	<b>ADVERTENCIA</b>	Este símbolo indica un riesgo o uso peligroso que podría causar graves heridas personales o incluso la muerte.
	<b>PRECAUCIÓN</b>	Este símbolo indica un riesgo o uso peligroso que podría causar heridas personales o daños al aparato o a otras propiedades.
	Situaciones prohibidas	
	Cuestiones que deben respetarse	

- Lea con atención estas instrucciones de funcionamiento antes de utilizar este acondicionador de aire. Si sigue teniendo alguna dificultad o problema, póngase en contacto con el distribuidor para que le ayude a solucionarlo.
- Este acondicionador de aire ha sido diseñado para proporcionarle un ambiente agradable en su habitación. Utilícelo solamente con la finalidad para la que ha sido diseñado, según se describe en estas instrucciones de funcionamiento.

## ⚠ ADVERTENCIA



Confirme con el distribuidor o especialista autorizado el tipo de refrigerante especificado que debe usar. El uso de un refrigerante distinto al tipo especificado puede acarrear daños al producto, explosiones, lesiones, etc.

---

Este acondicionador de aire no dispone de ventilador para introducir aire fresco del exterior. Cuando utilice en la misma sala aparatos de calefacción de gas o queroseno, que consumen mucho oxígeno del aire, debe abrir con frecuencia las puertas o ventanas. De lo contrario, en casos extremos, existe el riesgo de asfixia.

---



Nunca utilice ni guarde gasolina u otros productos o líquidos inflamables cerca del acondicionador de aire porque es muy peligroso.

---

No utilice este aparato en una atmósfera potencialmente explosiva.

---

No toque nunca la unidad con las manos mojadas.

---

No introduzca los dedos ni ningún otro objeto en la unidad interior o exterior del acondicionador de aire: las piezas giratorias pueden provocar heridas.



## ADVERTENCIA

 Si el refrigerante entra en contacto con una llama generará gas tóxico.

Por motivos de seguridad, asegúrese de apagar el acondicionador de aire y también de desconectar la alimentación antes de efectuar limpiezas o reparaciones.

En caso de emergencia, desconecte el enchufe de alimentación de la toma de corriente, apague el disyuntor o apague el elemento de desconexión de la alimentación para aislar el acondicionador de aire de la fuente de suministro eléctrico.



Deshágase de este producto según la legislación nacional o local.

 Este producto no debe modificarse ni desmontarse en ningún caso. La unidad modificada o desmontada podría provocar un incendio, descargas eléctricas o lesiones.

Los usuarios no deben limpiar el interior de las unidades interiores y exteriores. Encargue la limpieza a un distribuidor o especialista autorizado.

En caso de que este aparato funcione incorrectamente, no lo repare usted mismo. Póngase en contacto con el distribuidor de ventas o servicios para solicitar una reparación y para deshacerse del producto.

 Proporcione una toma de corriente que vaya a utilizarse exclusivamente para cada unidad, e instale un elemento de desconexión de la alimentación, un disyuntor de fugas a tierra (ELCB) o un dispositivo de corriente residual (RCD) a modo de protección contra sobrecorriente en la línea exclusiva.

Proporcione una toma de corriente para cada unidad; y en el cableado fijo deberán incorporarse medios para la desconexión completa del suministro eléctrico que tengan una separación de contacto en todos los polos en conformidad con las normas del cableado.

Para prevenir posibles peligros a causa de un fallo en el aislamiento, la unidad debe conectarse a tierra.



 No utilice cables manipulados, empalmados, prolongados o de origen desconocido, para evitar sobrecalentamientos y riesgo de incendios.



 El aparato deberá guardarse en una habitación en la que no existan fuentes de ignición en continuo funcionamiento (por ejemplo, llamas expuestas, aparatos de gas en funcionamiento o calentadores eléctricos en funcionamiento).

Procure que los refrigerantes no emitan olores.

Las zonas no ventiladas en la que se instale un aparato que utilice refrigerantes inflamables se deberá construir de forma que las fugas de refrigerante, en caso de producirse, no se estanquen hasta el punto que puedan crear un riesgo de incendio o explosión.

El aparato se debe almacenar en una zona bien ventilada en la que el tamaño de la habitación corresponda al área de la habitación especificada para el funcionamiento.

Tras instalar la unidad, pregunte siempre al instalador la superficie de suelo de la habitación en la que está instalada la unidad y la cantidad de carga de refrigerante.

Si la unidad o el divisor de la habitación cambian, pregunte siempre al distribuidor o al servicio de atención técnica.

 No utilice ningún método diferente al que recomienda el fabricante para acelerar el proceso de descongelación ni para realizar tareas de limpieza.

No perfore ni queme el aparato.

En los casos en los que sea necesario utilizar ventilación mecánica, los orificios de ventilación deberán estar libres de obstrucciones.



## ADVERTENCIA

 El aparato deberá guardarse en una habitación en la que no existan llamas expuestas (por ejemplo, aparatos de gas en funcionamiento) ni fuentes de ignición en continuo funcionamiento (por ejemplo, calentadores eléctricos en funcionamiento).

 Deje de utilizar el producto cuando haya cualquier anomalía/fallo y desconecte el cable de corriente o desactive el interruptor de alimentación y el interruptor. (Riesgo de humo/incendio/descarga eléctrica)  
Ejemplos de anomalía o fallo:

- El ELCB se activa frecuentemente.
- El producto a veces no se enciende al activar el interruptor.
- La corriente a veces se desconecta cuando se mueve el cable.
- Huele a quemado o se oyen ruidos anormales durante el funcionamiento.
- La carcasa presenta deformaciones o está anormalmente caliente.
- Filtraciones de agua desde la unidad interior.
- El cable de alimentación o el enchufe está excesivamente caliente.
- No se puede controlar la velocidad del ventilador.
- La unidad se para inmediatamente incluso estando en funcionamiento.
- El ventilador no se para incluso habiendo cesado la operación.

Póngase en contacto inmediatamente con su proveedor local para su mantenimiento/repación.

 No se siente ni se ponga de pie sobre la unidad. Podría caerse y sufrir un accidente. 

### AVISO

- El aparato deberá guardarse de tal modo que se eviten los daños mecánicos.
- El compresor podría detenerse ocasionalmente durante tormentas. Esta situación no representa un fallo mecánico. La unidad se recuperará automáticamente al cabo de unos minutos.
- El texto en inglés constituye las instrucciones originales. El resto de los idiomas son traducciones de las instrucciones originales.

## PRECAUCIÓN

 Este aparato está pensado para ser utilizado por expertos o usuarios con la cualificación necesaria en tiendas, en la industria ligera y en granjas, o por no expertos en usos comerciales.

Este aparato puede ser utilizado por niños a partir de 8 años de edad y por personas con capacidades físicas, sensoriales o mentales o falta de experiencia y conocimiento, siempre que hayan recibido supervisión o instrucciones en relación al uso del aparato de forma segura y entiendan los riesgos que dicho uso conlleva. Los niños no deben jugar con el aparato. Los procesos de limpieza y mantenimiento por parte del usuario no deberán correr a cargo de niños sin la debida supervisión.



Instale la alarma contra incendios y la salida de aire a una distancia mínima de 1,5 m de la unidad.

No caliente ni enfríe demasiado la sala si en ella se encuentran bebés o personas discapacitadas.

 No apague ni encienda el acondicionador de aire con el interruptor de alimentación. Utilice para ello el botón de operación de encendido/apagado (ON/OFF).

No introduzca nada en las salidas de aire de la unidad exterior. Esto es muy peligroso, porque el ventilador gira a alta velocidad. 

No toque la entrada de aire ni las afiladas aletas de aluminio de la unidad exterior. Podría hacerse daño. 

No pegue ningún objeto en la CARCASA DEL VENTILADOR. Podría sufrir lesiones y la unidad podría dañarse.  



# Precauciones de uso

## Instalación

- Este acondicionador deberá instalarlo correctamente un técnico especializado en instalaciones, cumpliendo siempre con las instrucciones de instalación suministradas con este aparato.
- Antes de hacer la instalación, compruebe si la tensión de alimentación eléctrica suministrada en su casa u oficina es la misma que la indicada en la placa de características.



## ADVERTENCIA

### A la hora de realizar la instalación, evite los siguientes lugares.

- Lugares en los que exista humo o gas combustible. Lugares con temperaturas extremadamente elevadas, como por ejemplo un invernadero.
- Lugares en los que haya objetos que generen un nivel de calor excesivo.

### Atención:

- Evite instalar la unidad exterior en lugares en los que agua salada pueda salpicar directamente al aparato, o en un lugar con presencia de aire sulfuroso, como por ejemplo cerca de un spa (El objetivo es proteger el acondicionador de aire de factores altamente corrosivos).

## Cableado

- Todas las conexiones deben cumplir con los códigos eléctricos locales (póngase en contacto con su concesionario o electricista cualificado para obtener más detalles).
- Cada unidad debe estar conectada a tierra correctamente, mediante un cable de puesta a tierra (masa) o a través del cableado de alimentación.
- Las conexiones debe realizarlas un electricista cualificado.

## Preparación del funcionamiento

### Active la alimentación eléctrica 5 horas antes de poner en marcha el equipo.

(El objetivo es que el dispositivo se caliente)

- Mantenga la alimentación eléctrica activada para uso continuo.



### NOTA

Si el aparato no va a utilizarse durante un periodo prolongado, desconecte el enchufe de alimentación de la toma de corriente, apague el disyuntor, o apague el elemento de desconexión de la alimentación para aislar el acondicionador de aire de la fuente de suministro eléctrico.

### Información para los usuarios relativa a la recopilación y eliminación de equipos y pilas usados



Estos símbolos en los productos, embalajes y/o documentos adjuntos, significan que los aparatos eléctricos y electrónicos y las baterías no deberían ser mezclados con los desechos domésticos.

Para un tratamiento, una recuperación y un reciclaje adecuados de los productos usados y de las pilas gastadas, llévelos a los puntos de recogida correspondientes, según la normativa de su país y las Directivas 2002/96/EC y 2006/66/EC.

Al deshacerse de estos productos y de estas pilas correctamente estará ayudando a ahorrar valiosos recursos y a evitar posibles efectos negativos para la salud humana y para el medio ambiente. La manipulación inadecuada de estos residuos podría provocar situaciones perniciosas.

Si desea obtener más información sobre la recopilación y el reciclaje de productos usados y de pilas gastadas, póngase en contacto con el ayuntamiento, con el servicio de recogida de basuras o con el punto de venta en el que compró los productos en cuestión.

El desecho incorrecto de estos residuos podría suponer la aplicación de multas según la normativa vigente.

### Para usuarios empresariales de la Unión Europea

Si desea deshacerse de productos eléctricos y electrónicos, póngase en contacto con su distribuidor o proveedor para obtener más información.

### [Información de desecho en otros países fuera de la Unión Europea]

Estos símbolos son válidos únicamente en la Unión Europea. Si desea deshacerse de estos productos, póngase en contacto con las autoridades locales o con su distribuidor y pregunte cuál es el método de desecho correcto.



### Nota para el símbolo de batería (ejemplos de dos símbolos de la parte inferior):

Este símbolo podría utilizarse en combinación con un símbolo de producto químico. En este caso cumple con los requisitos impuestos por la Directiva en relación al producto químico en cuestión.



# Nombres de las partes

## UNIDAD EXTERIOR

### Un solo split

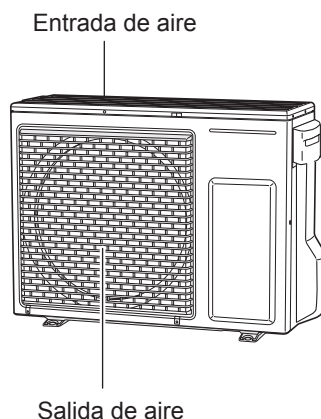

### Opcional

#### Unidad de mando a distancia inalámbrica

N.º de modelo  
CZ-RWS3



(Mando  
inalámbrico)

N.º de modelo  
CZ-RWSK2



#### Unidad de mando a distancia del temporizador



N.º de modelo  
CZ-RTC4

Para todas las  
unidades interiores

#### Mando a distancia con cable de altas prestaciones



N.º de modelo  
CZ-RTC5B

Para todas las  
unidades interiores

Lea las instrucciones de funcionamiento incluidas con el mando a distancia.

### ■ Funcionamiento

Consulte las instrucciones de funcionamiento adjuntas al mando a distancia opcional.

### ■ Ajuste de la dirección del flujo de aire

Consulte las instrucciones de funcionamiento adjuntas a la unidad interior y al mando a distancia opcional.

### ■ Mantenimiento







Consulte las instrucciones de funcionamiento adjuntas a la unidad interior.

### ■ Resolución de problemas

Consulte las instrucciones de funcionamiento adjuntas a la unidad interior.

## Marcas para la Directiva 2014/68/EU (PED)

Figura de la placa de características

<b>Panasonic</b>			<b>CE</b> 0035
Air Conditioner		<b>Model No.</b> A: Model Name Various	
POWER SOURCE : B: Various			
MAX ELECTRIC INPUT : C: kW A			
TIME DELAY FUSE MAX SIZE : D: A			
UNIT PROTECTION : IPX4			
Operating Spec. Area Various (Not for the PED)			
MAX.WORKING PRESSURE : HIGH SIDE E: bar ( MPa) Various LOW SIDE F: bar ( MPa) Various			
REFRIGERANT : R32 G: kg Various			
NET WEIGHT: Various (Not for the PED)			
SERIAL NO. : Various		PROD. DATE : YYYY.MM	
THE CAPACITY, CURRENT AND POWER INPUT ARE FOR THIS UNIT CONNECTED TO THE FOLLOWING INDOOR UNITS. Various (Not for the PED) FOR OTHER COMBINATIONS, REFER TO MANUAL.			
Authorized representative in EU Panasonic Testing Centre		Panasonic Marketing Europe GmbH Winsbergring 15, 22525 Hamburg, Germany	
Panasonic Corporation 1006 Kadoma, Kadoma City, Osaka, Japan			Made in Malaysia
<b>R32</b>    			
 THIS PRODUCT CONTAINS FLUORINATED GREENHOUSE GASES R 3 2 GWP=6 7 5			
Various			

### Tabulación de diversos datos

A	U-36PZH2E5	U-50PZH2E5	U-60PZH2E5
B	220 - 230 - 240 V~ 50 Hz		
C	2,40 kW, 11,0 A	2,68 kW, 12,0 A	3,54 kW, 16,4 A
D	20 A	20 A	25 A
E	41,5 bar (4,15 MPa)		
F	27,0 bar (2,70 MPa)		
G	1,15 kg	1,15 kg	1,45 kg

A	U-60PZ2E5	U-71PZ2E5
B	220 - 230 - 240 V~ 50 Hz	
C	3,54 kW, 16,4 A	3,54 kW, 16,4 A
D	25 A	25 A
E	41,5 bar (4,15 MPa)	
F	25,5 bar (2,55 MPa)	
G	1,45 kg	1,45 kg



Vielen Dank für den Kauf dieses Panasonic-Produkts. Bei diesem Produkt handelt es sich um ein handelsübliches Klimaanlage-Innengerät. Installationsanweisungen liegen bei.

# Inhalt

- **Sicherheitshinweise** ..... 20
- **Vorsichtsmaßnahmen für den Gebrauch** ..... 23
- **Bezeichnungen der Teile** ..... 24

---

- **Technische Daten** ..... 62
  - **Außengerät** ..... 62
  - **Sprachen-Entsprechungstabelle** ..... 62

	<b>WARNUNG</b>	Dieses Symbol macht darauf aufmerksam, dass dieses Gerät mit einem ein brennbaren Kühlmittel arbeitet. Wenn Kühlmittel austritt und eine externe Zündquelle vorhanden ist, besteht die Möglichkeit einer Entzündung.
	<b>VORSICHT</b>	Dieses Symbol weist darauf hin, dass das Wartungspersonal bei der Handhabung dieses Geräts Bezug auf die Technische Anleitung nehmen sollte.
	<b>VORSICHT</b>	Dieses Symbol macht darauf aufmerksam, dass Informationen in der Bedienungsanleitung oder Einbauanleitung enthalten sind.

## Produkt-Information

Falls Probleme oder Fragen zu dieser Klimaanlage auftreten sollten, die eine Kontaktaufnahme mit dem Kundendienst erforderlich machen, werden die folgenden Angaben benötigt. Modell- und Seriennummer befinden sich auf dem Typenschild.

Modellnummer \_\_\_\_\_

Seriennummer \_\_\_\_\_

Kaufdatum \_\_\_\_\_

Anschrift des Fachhändlers \_\_\_\_\_

Telefonnummer \_\_\_\_\_

### Wichtige Informationen über das verwendete Kältemittel

Dieses Produkt enthält fluorierte Treibhausgase. Lassen Sie Gase nicht in die Atmosphäre ab.

Kühlmitteltyp: R32



GWP<sup>(1)</sup>: 675

<sup>(1)</sup>GWP = global warming potential (Treibhauspotenzial)

Entsprechend der jeweiligen europäischen oder örtlichen Vorschriften können regelmäßige Kältemittel-Dichtigkeitsprüfungen vorgeschrieben sein. Weitere Informationen erhalten Sie von Ihrem Fachhändler.

# Sicherheitshinweise

In dieser Bedienungsanleitung werden die folgenden Symbole verwendet, um Benutzer und Kundendienstpersonal auf die Gefahr von Verletzungen bzw. Sachschäden und eine mögliche Beschädigung des Gerätes hinzuweisen:

	<b>WARNUNG</b>	Dieses Symbol warnt vor einer Gefahr oder vor unsachgemäßem Betrieb, wodurch Verletzungen mit möglicherweise tödlichem Ausgang entstehen können.
	<b>VORSICHT</b>	Dieses Symbol warnt vor einer Gefahr oder vor unsachgemäßem Betrieb, die zu Verletzungen, einer Beschädigung des Gerätes und anderen Sachschäden führen könnten.

	Untersagte Handlungen		Zu beachtende Punkte
---	-----------------------	---	----------------------

- Vor Inbetriebnahme dieser Klimaanlage sollten Sie diese Bedienungsanleitung aufmerksam durchlesen. Falls Sie danach immer noch irgendwelche Schwierigkeiten oder Fragen haben sollten, wenden Sie sich bitte an Ihren Fachhändler.
- Diese Klimaanlage ist so konstruiert, dass sie für ein angenehmes Raumklima sorgt. Verwenden Sie sie nur für den beabsichtigten Zweck gemäß der Beschreibung in dieser Bedienungsanleitung.

## ! WARNUNG



Fragen Sie Ihren Vertragshändler oder Spezialisten nach dem Gebrauch des vorgeschriebenen Kältemitteltyps. Wird ein anderes Kältemittel als das vorgeschriebene verwendet, kann es zu einer Beschädigung des Produkts, Rohrbruch und Verletzungen usw. kommen.

---

Diese Klimaanlage besitzt keinen Ventilator zum Ansaugen von Frischluft. Werden Gas- oder Ölheizgeräte, die viel Sauerstoff verbrauchen, im gleichen Raum betrieben, so müssen Fenster und Türen häufig geöffnet werden, um die Luft im Raum zu erneuern.  
Anderenfalls besteht in extremen Fällen Erstickungsgefahr!

---



Auf keinen Fall Benzin oder andere zündfähige Gase oder Flüssigkeiten in der Nähe der Klimaanlage verwenden oder lagern — Explosionsgefahr!

---

Das Gerät darf nicht in explosionsgefährdeten Bereichen verwendet werden.

---

Fassen Sie das Gerät nie mit nassen Händen an.

---

Stecken Sie weder Ihre Finger noch andere Objekte in das Innen- oder Außengerät der Klimaanlage, da es zu Verletzungen durch sich drehende Teile kommen kann.



## **WARNUNG**



Wenn das Kühlmittel mit einer Flamme in Berührung kommt, wird ein toxisches Gas erzeugt.

Schalten Sie die Klimaanlage vor der Reinigung oder Wartung zur Sicherheit aus, und trennen Sie das Gerät von der Spannungsquelle.

In Notfällen ziehen Sie den Stecker aus der Netzsteckdose, schalten Sie den Trennschalter aus, oder schalten Sie das entsprechende Trennorgan ab, um das Innengerät von der Netzspannung zu trennen.



In Übereinstimmung mit den gültigen nationalen und örtlichen Vorschriften entsorgen.



Dieses Produkt darf unter keinen Umständen abgeändert oder zerlegt werden. Ein Abändern oder Zerlegen der Einheit kann einen Brand, einen Stromschlag oder eine Verletzung verursachen.

Das Innere von Innen- und Außengeräten darf nicht von Benutzern gereinigt werden. Beauftragen Sie einen autorisierten Händler oder Servicetechniker mit der Reinigung.

Sollte eine Betriebsstörung dieses Geräts auftreten, versuchen Sie nicht, diese eigenhändig zu beseitigen. Beauftragen Sie den Vertrieb oder Fachhändler mit Instandsetzungsarbeiten und der Entsorgung.



Für den Anschluss jedes Geräts muss eine separate Steckdose vorhanden sein; innerhalb des ausschließlich für das Gerät verwendeten Stromversorgungskabels muss ein Trennschalter, ein Fehlerstromschutzschalter oder eine Fehlerstrom-Schutzeinrichtung zum Schutz gegen Überstrom vorhanden sein.

Jedes Gerät muss zur Stromversorgung an einen eigenen Netzanschluss angeschlossen werden. Außerdem muss ein Trennschalter mit Trennabstand an allen Kontakten nach den vor Ort geltenden Verdrahtungsvorschriften in die Festverdrahtung eingebaut werden.

Zum Schutz vor Gefahren durch Mängel in der Isolierung muss das Gerät geerdet werden.



Verwenden Sie keine veränderten Kabel, keine Mehrfachstecker, Verlängerungskabel oder Kabel ohne Spezifikation, um ein Überhitzen und einen Brand zu vermeiden.



Das Gerät ist in einem Raum ohne andauernd arbeitende Zündquellen (z. B. offene Flammen, in Betrieb befindliches Gasgerät oder in Betrieb befindliche Elektroheizung) zu lagern.

Kühlmittel können geruchlos sein.

Ein nicht belüfteter Bereich, an dem das mit brennbaren Kühlmitteln arbeitende Gerät installiert wird, ist so auszuführen, dass in dem Fall, dass Kühlmittel austritt, dieses nicht stockt und dadurch eine Brand- oder Explosionsgefahr hervorruft.

Das Gerät ist in einem gut belüfteten Bereich zu lagern, wo die Raumgröße dem für den Betrieb vorgeschriebenen Raumvolumen entspricht.

Versäumen Sie nach der Installation des Geräts nicht, den Installateur nach der Bodenfläche des Raums, in dem das Gerät installiert ist, sowie der Kühlmittel-Füllmenge zu fragen.

Wenn das Gerät ausgetauscht oder die Raumaufteilung geändert werden soll, lassen Sie sich unbedingt von einem Vertrieb oder Kundendienst beraten.



Enteisung und Wartung nicht durch andere als die vom Hersteller empfohlenen Mittel beschleunigen.

Nicht durchstechen oder verbrennen.

In Fällen, die eine mechanische Lüftung erfordern, sind Lüftungsöffnungen von Hindernissen freizuhalten.

## **WARNUNG**



Das Gerät ist in einem Raum ohne andauernd in Betrieb befindlichen offenen Flammen (z. B. in Betrieb befindliches Gasgerät) und Zündquellen (z. B. in Betrieb befindliche Elektroheizung) zu lagern.



Im Fall einer Funktionsstörung oder einer Fehlfunktion ist das Produkt auszuschalten und der Netzstecker zu ziehen bzw. der Sicherungsautomat zu öffnen.

(Gefahr von Rauchbildung/Feuer/  
Stromschlag)

Beispiele für Funktionsstörungen bzw. Fehlfunktionen:

- Der Fehlerstrom-Schutzschalter löst häufig aus.
  - Das Gerät startet manchmal nicht, wenn Sie es einschalten.
  - Die Stromversorgung wird manchmal unterbrochen, wenn Sie das Kabel bewegen.
  - Brandgeruch oder ungewöhnliche Geräusche während des Betriebs.
  - Das Gehäuse ist verformt oder ungewöhnlich heiß.
  - Wasser tropft aus dem Innengerät.
  - Das Netzkabel bzw. der Netzstecker wird ungewöhnlich warm.
  - Die Ventilator Drehzahl wird nicht geregelt.
  - Das Gerät bleibt sofort stehen, wenn es eingeschaltet wird.
  - Der Ventilator bleibt nicht stehen, wenn das Gerät abgeschaltet wird.
- Wenden Sie sich für Wartungs- und Reparaturarbeiten umgehend an Ihren Fachhändler.



Setzen oder stellen Sie sich nicht auf das Gerät. Es besteht Sturzgefahr.



## **VORSICHT**



Das Gerät kann sowohl von Experten und geschulten Anwendern, in Geschäften, in der Leichtindustrie und Landwirtschaft, als auch von Endverbrauchern eingesetzt werden.

Das Gerät kann von Kindern ab 8 Jahren, von Personen mit eingeschränkten physischen, mentalen oder sensorischen Fähigkeiten sowie von Personen ohne ausreichende Erfahrung und Kenntnis bedient werden, vorausgesetzt, sie werden während der Bedienung beaufsichtigt, über die potenziellen Gefahren aufgeklärt und erhalten eine entsprechende Anleitung zur sicheren Bedienung des Geräts. Kinder dürfen nicht mit dem Gerät spielen. Die Reinigung und Benutzer-Wartungshandgriffe dürfen nicht von Kindern ohne Aufsicht durchgeführt werden.

Feuermelder und Luftauslass müssen mindestens 1,5 m vom Gerät entfernt sein.

Achten Sie stets darauf, den Raum nicht zu stark zu kühlen oder zu heizen, wenn Kleinkinder oder Kranke anwesend sind.



Schalten Sie die Klimaanlage nicht mit Hilfe des Netztrennschalters ein und aus. Verwenden Sie dazu grundsätzlich die Betriebstaste (ON/OFF).

Stecken Sie keine Gegenstände in den Luftauslass des Außengeräts. Dies ist gefährlich, weil der Ventilator mit hoher Drehzahl rotiert.



Berühren Sie nicht den Lufteinlass oder die scharfen Aluminium-Kühlrippen am Außengerät. Es besteht Verletzungsgefahr.



Kleben Sie keine Objekte auf das VENTILATORGEHÄUSE. Es besteht die Gefahr von Verletzungen und Geräteschäden.



### **HINWEIS**

- Das Gerät ist so zu lagern, dass eine mechanische Beschädigung ausgeschlossen ist.
- Es kann vorkommen, dass der Betrieb des Kompressors bei Gewittern unterbrochen wird. Das Gerät nimmt nach einigen Minuten automatisch den Betrieb wieder auf.
- Bei der englischen Textfassung handelt es sich um das Original. Bei den Anleitungen in anderen Sprachen handelt es sich um Übersetzungen des Originals.

# Vorsichtsmaßnahmen für den Gebrauch

## Installation

- Dieses Klimagerät muss von einem qualifizierten Montagetechniker gemäß der beigelegten Montageanleitung fachgerecht installiert werden.
- Vor der Installation nachprüfen, dass die Netzspannung mit der auf dem Typenschild angegebenen Spannung übereinstimmt.

## WARNUNG

### Die nachstehenden Installationsorte sind zu vermeiden.

- Orte mit Rauchentwicklung und brennbarem Gas. Auch Orte mit extrem hohen Temperaturen wie Treibhäuser.
- Orte, an denen hohe Wärme erzeugende Einrichtungen aufgestellt sind.

### Achtung:

- Das Außengerät darf nicht an einem Ort installiert werden, wo es Salzwasserspritzern oder schwefelhaltiger Luft, z.B. in der Nähe von Heilquellen, ausgesetzt ist. (Zum Schutz des Klimageräts vor starker Korrosion)

## Verdrahtung

- Die gesamte Verdrahtung muss in Übereinstimmung mit den örtlichen Vorschriften erfolgen. (Einzelheiten erfahren Sie von Ihrem Fachhändler oder einem qualifizierten Elektriker.)
- Alle Geräte müssen entweder über eine Erdleitung oder über die Netzzuleitung fachgerecht geerdet werden.
- Die Verdrahtung muss von einem qualifizierten Elektriker vorgenommen werden.

## Betriebsvorbereitung

### Schalten Sie die Stromversorgung 5 Stunden vor Betriebsbeginn ein.

(Zum Aufwärmen)

- Lassen Sie die Stromversorgung während des andauernden Gebrauchs eingeschaltet.



### ZUR BEACHTUNG

Wenn das Innengerät längere Zeit nicht verwendet wird, ziehen Sie den Stecker aus der Netzsteckdose, schalten Sie den Trennschalter aus, oder schalten Sie das entsprechende Trennorgan ab, um das Innengerät von der Netzspannung zu trennen.

### Benutzerinformation zur Sammlung und Entsorgung von Altgeräten und verbrauchten Batterien



Diese Symbole auf den Produkten, Verpackungen und/oder Begleitdokumenten bedeuten, dass gebrauchte elektrische und elektronische Produkte und Batterien nicht in den allgemeinen Hausmüll gegeben werden dürfen.

Bitte bringen Sie alte Produkte und verbrauchte Batterien zur korrekten Behandlung für Aufarbeitung und Recycling in Übereinstimmung mit der Landesgesetzgebung und den Richtlinien 2002/96/EG und 2006/66/EG zu den zuständigen Sammelstellen.

Durch die vorschriftsmäßige Entsorgung dieser Produkte und Batterien tragen Sie zum Schutz wertvoller Ressourcen und zur Vermeidung potenziell negativer Auswirkungen auf die menschliche Gesundheit und die Umwelt bei, die anderenfalls durch eine unsachgemäße Abfallbehandlung entstehen können.

Für weitere Informationen zu Sammlung und Recycling von alten Produkten und Batterien wenden Sie sich bitte an Ihre Gemeinde- oder Stadtverwaltung, das örtliche Entsorgungsunternehmen oder die Verkaufsstelle, bei der die Gegenstände erworben wurden. Eine nicht vorschriftsmäßige Entsorgung solcher Abfälle kann je nach Landesgesetzgebung strafbar sein.

### An kommerzielle Benutzer in der Europäischen Union

Wenn Sie elektrische oder elektronische Geräte entsorgen möchten, wenden Sie sich bitte an Ihren Händler oder Lieferanten. Dort erhalten Sie weitere Informationen.

### [Informationen zur Entsorgung in Ländern außerhalb der Europäischen Union]

Diese Symbole sind nur in der Europäischen Union gültig. Wenn Sie diese Gegenstände entsorgen möchten, wenden Sie sich an die örtliche Behörde oder an Ihren Händler und fragen Sie nach der korrekten Entsorgungsmethode.



### Anmerkung zum Batteriesymbol (unten mit zwei Kennbuchstaben als Beispiel):

Dieses Symbol kann in Kombination mit einem chemischen Symbol verwendet werden. In diesem Fall erfüllt es die Anforderungen der für die betreffende Chemikalie erlassenen Richtlinie.



# Bezeichnungen der Teile

## AUßENGERÄT

### Einzel-Split

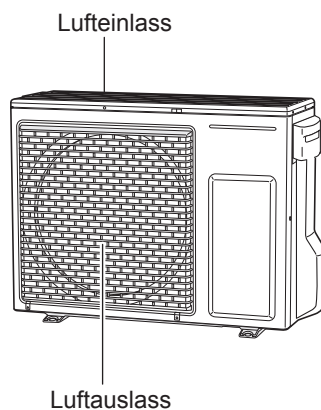

## Optional

### Infrarot-Fernbedienung

Modellnummer  
CZ-RWS3



(Infrarot-  
Fernbedienung)

Modellnummer  
CZ-RWSK2



### Timer-Fernbedienung



Modellnummer  
CZ-RTC4

Für alle  
Innengeräte

### Speziellen Kabelfernbedienung



Modellnummer  
CZ-RTC5B

Für alle  
Innengeräte

Lesen Sie die mit der Fernbedienung gelieferte Bedienungsanleitung.

### ■ Betrieb

Lesen Sie die mit der optionalen Fernbedienung gelieferte Bedienungsanleitung.

### ■ Anpassung der Richtung des Luftstroms

Lesen Sie sich auf die dem Innengerät und der optionalen Fernbedienung gelieferte Bedienungsanleitung.

### ■ Wartung

Lesen Sie die mit dem Innengerät gelieferte Bedienungsanleitung.

### ■ Fehlerbehebung

Lesen Sie die mit dem Innengerät gelieferte Bedienungsanleitung.



## Markierungen für die EG-Richtlinie 2014/68/EU (PED)

Abbildung des Typenschildes

<b>Panasonic</b>			<b>CE</b> 0035
Air Conditioner		<b>Model No.</b> A: Model Name Various	
POWER SOURCE : B: Various			
MAX ELECTRIC INPUT C: kW A			
TIME DELAY FUSE MAX SIZE : D: A			
UNIT PROTECTION : IPX4			
Operating Spec. Area Various (Not for the PED)			
MAX.WORKING PRESSURE : HIGH SIDE E: bar ( MPa) Various LOW SIDE F: bar ( MPa) Various			
REFRIGERANT : R32 G: kg Various			
NET WEIGHT: Various (Not for the PED)			
SERIAL NO. : Various		PROD. DATE : YYYY.MM	
THE CAPACITY, CURRENT AND POWER INPUT ARE FOR THIS UNIT CONNECTED TO THE FOLLOWING INDOOR UNITS. Various (Not for the PED) FOR OTHER COMBINATIONS, REFER TO MANUAL.			
Authorized representative in EU Panasonic Testing Centre		Panasonic Marketing Europe GmbH Winsbergring 15, 22525 Hamburg, Germany	
Panasonic Corporation 1006 Kadoma, Kadoma City, Osaka, Japan			Made in Malaysia
<b>R32</b>    			
 THIS PRODUCT CONTAINS FLUORINATED GREENHOUSE GASES R 3 2 GWP=6 7 5			
Various			

DEUTSCH

### Tabellarische Übersicht verschiedener Daten

	U-36PZH2E5	U-50PZH2E5	U-60PZH2E5
B	220 - 230 - 240 V~ 50 Hz		
C	2,40 kW, 11,0 A	2,68 kW, 12,0 A	3,54 kW, 16,4 A
D	20 A	20 A	25 A
E	41,5 bar (4,15 MPa)		
F	27,0 bar (2,70 MPa)		
G	1,15 kg	1,15 kg	1,45 kg



	U-60PZ2E5	U-71PZ2E5
B	220 - 230 - 240 V~ 50 Hz	
C	3,54 kW, 16,4 A	3,54 kW, 16,4 A
D	25 A	25 A
E	41,5 bar (4,15 MPa)	
F	25,5 bar (2,55 MPa)	
G	1,45 kg	1,45 kg

Grazie per aver acquistato questo prodotto Panasonic. Il prodotto è l'unità interna di un condizionatore d'aria commerciale.

Istruzioni di installazione allegate.

# Indice

● Precauzioni per la sicurezza .....	26
● Precauzioni per l'uso .....	29
● Nome delle parti .....	30
● Specifiche .....	62
• Unità esterna .....	62
• Terminologia nelle varie lingue .....	62

	<b>AVVERTENZA</b>	Questo simbolo indica che questa apparecchiatura utilizza refrigerante infiammabile. Se si verifica una perdita di refrigerante, in presenza di una fonte di accensione esterna, vi è la possibilità di accensione.
	<b>ATTENZIONE</b>	Questo simbolo indica che la manipolazione di questa apparecchiatura deve essere eseguita da personale di servizio facendo riferimento al Manuale tecnico.
	<b>ATTENZIONE</b>	Questo simbolo indica che vi sono informazioni incluse nelle Istruzioni per l'uso e/o nelle Istruzioni per l'installazione.

## Informazioni riguardanti il prodotto

In caso di difficoltà o se si hanno dei dubbi riguardo al condizionatore d'aria, sono necessarie le informazioni seguenti. La sigla del modello e il numero seriale sono riportati sulla targhetta applicata.

No. modello
_____
No. di serie
_____
Data di acquisto
_____
Indirizzo del rivenditore
_____
Numero di telefono

### Informazioni importanti relative al refrigerante utilizzato

Questo prodotto contiene gas fluorurati ad effetto serra. Non scaricare i gas nell'atmosfera.

Tipo di refrigerante: R32





Valore GWP<sup>(1)</sup>: 675

<sup>(1)</sup>GWP = global warming potential - potenziale di riscaldamento globale

A seconda delle disposizioni vigenti a livello locale e europeo, può essere necessario svolgere periodicamente dei controlli per verificare l'assenza di perdite di refrigerante. Per ulteriori informazioni contattare il distributore locale.

# Precauzioni per la sicurezza

In questo manuale vengono utilizzati i seguenti simboli per segnalare condizioni potenzialmente pericolose per gli utenti, il personale di servizio o l'apparecchio:

	<b>AVVERTENZA</b>	Questo simbolo indica pericoli o interventi non sicuri che possono provocare gravi lesioni personali o la morte.
	<b>ATTENZIONE</b>	Questo simbolo indica pericoli o interventi non sicuri che possono provocare lesioni personali o danni al prodotto stesso o ad altre cose.
	Operazioni vietate	
	Operazioni da eseguire	

- Leggete attentamente questi istruzioni per l'uso prima di usare il condizionatore d'aria. In caso di dubbi o problemi, rivolgersi al proprio rivenditore.
- Questo condizionatore d'aria è progettato per rendere confortevoli le condizioni ambientali dei locali. Utilizzarlo soltanto per lo scopo previsto, come descritto in queste istruzioni per l'uso.

## AVVERTENZA



Consultare un rivenditore autorizzato o uno specialista relativamente all'utilizzo del tipo di refrigerante specificato. L'utilizzo di refrigerante diverso dal tipo specificato potrebbe provocare danni al prodotto, esplosioni, lesioni personali ecc.

Questo condizionatore d'aria non ha una ventola di aspirazione dell'aria fresca dall'esterno. Occorre pertanto aprire frequentemente le porte e le finestre se si utilizzano apparecchiature di riscaldamento a gas o cherosene nella stessa stanza, perché consumano molto ossigeno. In caso contrario, in casi estremi sussiste il pericolo di asfissia.



Mai usare o conservare benzina o altri vapori o liquidi infiammabili vicino al condizionatore, perché ciò è molto pericoloso.

Non utilizzare questo apparecchio in un'atmosfera potenzialmente esplosiva.

Mai toccare l'unità con le mani bagnate.

Non inserire le dita o altri oggetti nell'unità interna o esterna del condizionatore d'aria. In caso contrario, le parti rotanti potrebbero causare lesioni.



## AVVERTENZA

 Se il refrigerante entra in contatto con una fiamma, produce un gas tossico.

Per la sicurezza, accertarsi di spegnere il condizionatore d'aria e anche di scollegare l'alimentazione elettrica prima di sottoporre l'apparecchio a pulizia o manutenzione.

In caso di emergenza, estrarre la spina di alimentazione dalla presa, oppure spegnere l'interruttore principale (di rete) o l'interruttore automatico per isolare il condizionatore dall'alimentazione di rete. 

Smaltire secondo le normative nazionali e/o locali.

 Questo prodotto non deve essere modificato o smontato in nessun caso. L'unità modificata o smontata può causare incendio, scosse elettriche o lesioni personali.



Non pulire da sé le unità interne ed esterne. Affidare la pulizia a un rivenditore o a un tecnico autorizzato.

In caso di malfunzionamento dell'apparecchio, non tentare di ripararlo da sé. Per le riparazioni e lo smaltimento, rivolgersi al proprio rivenditore o a un centro di assistenza.

 Collegare ciascuna unità a una presa di corrente dedicata e nella linea esclusiva installare un sezionatore, un interruttore differenziale contro le perdite a terra (ELCB) o un interruttore differenziale (RCD) per la protezione da sovracorrente.

Collegare ciascuna unità a una presa di corrente dedicata, e incorporare nel cablaggio fisso un sistema di scollegamento completo, che offra una separazione dei contatti su tutti i poli, in ottemperanza alle normative sui cablaggi.

Per evitare possibili pericoli dovuti a interruzione dell'isolamento elettrico, l'unità deve essere provvista di messa a terra. 

 Non utilizzare un cavo modificato o giuntato, una prolunga o un cavo diverso da quello specificato per evitare surriscaldamenti e incendi.  

 L'apparecchio deve essere posizionato in un locale privo di fonti di accensione funzionanti in modo continuo (ad esempio fiamme libere, apparecchi a gas o riscaldatori elettrici funzionanti).

Tenere presente che i refrigeranti possono essere inodori.

Se si installa l'apparecchio, che utilizza refrigeranti infiammabili, in un'area non ventilata, tale area deve essere strutturata in modo tale che eventuali perdite di refrigerante non possano stagnare creando il rischio di incendio o di esplosione.

L'apparecchio deve essere posizionato in un locale ben ventilato, delle dimensioni specificate per il funzionamento.

Dopo l'installazione dell'unità, chiedere all'installatore la superficie del locale in cui è installata l'unità e la quantità di carica del refrigerante.

In caso di cambiamenti dell'unità o dei divisori del locale, consultare il rivenditore o il servizio di assistenza.

 Per accelerare il processo di sbrinamento o per la pulizia, non utilizzare mezzi diversi da quelli raccomandati dal produttore.

Non perforare né bruciare.

Qualora sia richiesta la ventilazione meccanica, le bocchette di ventilazione devono essere mantenute prive di ostacoli.



## **AVVERTENZA**

 L'apparecchio deve essere posizionato in un locale privo di fiamme libere funzionanti in modo continuo (ad esempio apparecchi a gas funzionanti) e fonti di accensione (ad esempio riscaldatori elettrici funzionanti).

 Al verificarsi di anomalie/guasti, interrompere l'uso del prodotto e scollegare la spina dalla presa di alimentazione, oppure spegnere l'interruttore di alimentazione e l'interruttore automatico. (rischio di fumo/incendio/scosse elettriche)  
Esempi di anomalia/guasto:

- L'interruttore differenziale scatta di frequente.
- Il prodotto a volte non si avvia quando viene acceso.
- L'alimentazione elettrica a volte si interrompe quando si sposta il cavo.
- Durante il funzionamento si rilevano odore di bruciato o rumori anomali.
- Il corpo risulta deformato o eccessivamente caldo.
- L'unità interna perde acqua.
- Il cavo o la spina di alimentazione si scaldano in maniera anomala.
- Non è possibile controllare la velocità della ventola.
- L'unità si arresta immediatamente quando la si accende.
- La ventola non si ferma neanche se si spegne l'apparecchio.

Contattare immediatamente il rivenditore locale per la manutenzione/riparazione.

 Non sedersi o salire in piedi sull'unità. C'è il pericolo di cadere. 

### **AVVISO**

- L'apparecchio deve essere conservato in modo da evitare il verificarsi di danni meccanici.
- Il compressore potrebbe occasionalmente arrestarsi durante i temporali con fulmini. Non si tratta di un guasto meccanico. L'unità riprende automaticamente a funzionare dopo qualche minuto.
- Le istruzioni originali sono il testo in inglese. Le altre lingue sono traduzioni delle istruzioni originali.

## **ATTENZIONE**

 Questo apparecchio è destinato all'utilizzo da parte di utenti esperti o preparati nei negozi, nell'industria leggera e nelle fattorie, oppure per l'utilizzo commerciale da parte di non addetti ai lavori.

Questo apparecchio può essere utilizzato dai minori a partire dagli 8 anni di età e da persone con capacità fisiche, sensoriali o mentali ridotte o da persone inesperte, a condizione che siano adeguatamente supervisionate o preventivamente istruite sull'utilizzo in sicurezza e informate sui pericoli presenti. I bambini non devono giocare con l'apparecchio. La pulizia e la manutenzione da parte dell'utente non devono essere effettuate da bambini senza supervisione.



Posizionare l'allarme antincendio e l'uscita dell'aria a una distanza di almeno 1,5 m dall'unità.

Non raffreddare o riscaldare eccessivamente la stanza in presenza di bambini molto piccoli o persone malate.

 Non accendere e spegnere il condizionatore d'aria mediante l'interruttore principale (di rete). Usare sempre il pulsante di accensione/spegnimento (ON/OFF).

Non inserire alcun oggetto nell'uscita d'aria dell'unità esterna.  Ciò è molto pericoloso perché la ventola ruota ad alta velocità.

Non toccare la presa d'aria o le alette di alluminio affilate dell'unità esterna. C'è il pericolo di ferirsi. 

Non attaccare alcun oggetto sulla SUPERFICIE ESTERNA DELLA VENTOLA.   C'è il pericolo di ferirsi e di danneggiare l'unità.

# Precauzioni per l'uso

## Installazione

- Questo condizionatore d'aria deve essere installato da installatori qualificati seguendo le istruzioni di installazione fornite con l'unità.
- Prima dell'installazione, accertare che la tensione di rete dell'ufficio o di casa corrisponda con quella indicata sulla targhetta di identificazione del condizionatore d'aria.



## AVVERTENZA

### Evitare l'installazione nei seguenti luoghi.

- Luoghi con presenza di fumo o gas combustibile. Anche luoghi con temperature molto alte quali le serre.
- Luoghi con presenza di apparecchiature che generano un calore eccessivo.

### Attenzione:

- Non installare l'unità esterna dove possa essere esposta direttamente agli spruzzi d'acqua marina o a vapori solforosi nelle vicinanze di stazioni termali.  
(Per proteggere il condizionatore d'aria dall'eccessiva corrosione)

## Allacciamenti elettrici

- Tutti gli allacciamenti elettrici devono essere conformi alle normative elettriche locali. (Per i dettagli, rivolgersi al proprio rivenditore o a un elettricista specializzato.)
- Ciascuna unità deve essere collegata correttamente a massa, con un filo di massa (terra) o mediante il cablaggio di alimentazione.
- Gli allacciamenti elettrici devono essere eseguiti da un elettricista specializzato.

## Preparazione alla messa in funzione

### Accendere l'interruttore principale (di rete) 5 ore prima della messa in funzione.

(Per il riscaldamento)

- Lasciare l'interruttore principale acceso per l'uso continuativo.



### NOTA

Quando non si intende utilizzare il condizionatore d'aria per un periodo di tempo prolungato, estrarre la spina di alimentazione dalla presa, oppure spegnere l'interruttore principale (di rete) o l'interruttore automatico per isolare il condizionatore dall'alimentazione di rete.

### Informazioni per gli utenti sulla raccolta e lo smaltimento di apparecchiature vecchie e batterie usate



Questi simboli sui prodotti, sugli imballaggi e/o sulla documentazione in dotazione significano che i prodotti elettrici ed elettronici usati e le batterie non devono essere smaltiti insieme ai rifiuti domestici.

Per il corretto trattamento, recupero e riciclo di prodotti vecchi e batterie usate, conferirli presso gli appositi centri di raccolta, in conformità con la legislazione nazionale e le Direttive 2002/96/CE e 2006/66/CE.

Il corretto smaltimento di questi prodotti e delle batterie concorre a salvaguardare risorse preziose e previene potenziali effetti nocivi per la salute umana e l'ambiente causati da uno smaltimento non corretto dei rifiuti.

Per ulteriori informazioni sulla raccolta e il riciclo di prodotti vecchi e batterie usate, rivolgersi alle autorità locali, al centro di smaltimento rifiuti locale o al proprio rivenditore.

A seconda della legislazione nazionale, lo smaltimento incorretto di questo rifiuto può essere soggetto a sanzioni.

### Per gli utenti commerciali nell'Unione Europea

Per ulteriori informazioni sullo smaltimento delle apparecchiature elettriche ed elettroniche, rivolgersi al proprio rivenditore o fornitore.

### [Informazioni sullo smaltimento al di fuori dell'Unione Europea]

Questi simboli sono validi solo nell'Unione Europea. Per il corretto smaltimento di questi prodotti, rivolgersi alle autorità locali o al proprio rivenditore.



### Nota relativa al simbolo della batteria (esempio con simbolo chimico riportato sotto il simbolo principale):

Questo simbolo può venire usato insieme a un simbolo chimico. Il questo caso è conforme ai requisiti della Direttiva relativamente alla sostanza chimica in questione.



# Nome delle parti

## UNITÀ ESTERNA

### Split Singolo

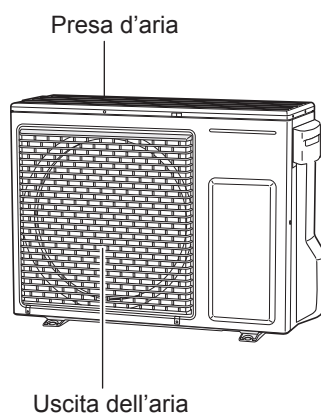

## Opzionale

### Telecomando senza fili

No. modello  
CZ-RWS3



(Telecomando  
wireless)

No. modello  
CZ-RWSK2



### Telecomando del timer



No. modello  
CZ-RTC4

Per tutte le  
unità interne

### Telecomando cablato di alto livello



No. modello  
CZ-RTC5B

Per tutte le  
unità interne

Leggere le Istruzioni per l'uso fornite con il telecomando.

### ■ Funzionamento

Fare riferimento alle Istruzioni per l'uso allegate al telecomando opzionale.

### ■ Regolazione della direzione del flusso d'aria

Fare riferimento alle Istruzioni per l'uso allegate all'unità interna e al telecomando opzionale.

### ■ Manutenzione







Fare riferimento alle Istruzioni per l'uso allegate all'unità interna.

### ■ Risoluzione dei problemi

Fare riferimento alle Istruzioni per l'uso allegate all'unità interna.

## Contrassegni conformi alla Direttiva 2014/68/EU (PED)

Targhetta dei dati nominali

<b>Panasonic</b>			<b>CE</b> 0035
Air Conditioner		<b>Model No.</b> A: Model Name Various	
POWER SOURCE : B: Various			
MAX ELECTRIC INPUT : C: kW A			
TIME DELAY FUSE MAX SIZE : D: A			
UNIT PROTECTION : IPX4			
Operating Spec. Area Various (Not for the PED)			
MAX.WORKING PRESSURE : HIGH SIDE E: bar ( MPa) Various LOW SIDE F: bar ( MPa) Various			
REFRIGERANT : R32 G: kg Various			
NET WEIGHT: Various (Not for the PED)			
SERIAL NO. : Various		PROD. DATE : YYYY.MM	
THE CAPACITY, CURRENT AND POWER INPUT ARE FOR THIS UNIT CONNECTED TO THE FOLLOWING INDOOR UNITS. Various (Not for the PED) FOR OTHER COMBINATIONS, REFER TO MANUAL.			
Authorized representative in EU Panasonic Testing Centre		Panasonic Marketing Europe GmbH Winsbergring 15, 22525 Hamburg, Germany	
Panasonic Corporation 1006 Kadoma, Kadoma City, Osaka, Japan			Made in Malaysia
    			
 THIS PRODUCT CONTAINS FLUORINATED GREENHOUSE GASES R 3 2 GWP=6 7 5 Various			

ITALIANO

### Tabelle dei dati tecnici



A	U-36PZH2E5	U-50PZH2E5	U-60PZH2E5
B	220 - 230 - 240 V~ 50 Hz		
C	2,40 kW, 11,0 A	2,68 kW, 12,0 A	3,54 kW, 16,4 A
D	20 A	20 A	25 A
E	41,5 bar (4,15 MPa)		
F	27,0 bar (2,70 MPa)		
G	1,15 kg	1,15 kg	1,45 kg

A	U-60PZ2E5	U-71PZ2E5
B	220 - 230 - 240 V~ 50 Hz	
C	3,54 kW, 16,4 A	3,54 kW, 16,4 A
D	25 A	25 A
E	41,5 bar (4,15 MPa)	
F	25,5 bar (2,55 MPa)	
G	1,45 kg	1,45 kg

Hartelijk dank voor het aanschaffen van dit Panasonic product.  
Dit product is een commerciële airconditioner binnenunit.  
Installatie-instructies worden meegeleverd.

# Inhoud

● Veiligheidsmaatregelen .....	32
● Voorzorgen in het gebruik .....	35
● Namen van de onderdelen .....	36
<hr/>	
● Technische gegevens .....	62
• Buitenunit .....	62
• Corresponderende talentabel .....	62

 <b>WAARSCHUWING</b>	Dit symbool geeft aan dat deze apparatuur gebruik maakt van een ontvlambaar koelmiddel. Als er koelmiddel lekt en er een externe ontstekingsbron aanwezig is, dan kan het middel ontbranden.
 <b>LET OP</b>	Dit symbool geeft aan dat deze apparatuur gehanteerd moet worden door gekwalificeerd servicepersoneel met inachtneming van de technische handleiding.
 <b>LET OP</b>	Dit symbool geeft aan dat er informatie over dit onderwerp is in de handleiding en/of de installatie-instructies.

## Productinformatie

Zorg ervoor dat u beschikt over de volgende informatie als u problemen of vragen hebt met betrekking tot de airconditioner. De model- en serienummers bevinden zich op het naamplaatje.

Modelnr.	_____
Serienr.	_____
Aanschafdatum	_____
Adres van dealer	_____
Telefoonnummer	_____

### Belangrijke informatie betreffende het gebruikte koelmiddel

Dit product bevat gefluoreerde broeikasgassen. Laat deze gassen niet in de atmosfeer ontsnappen.

Koelmiddeltipe: R32



GWP-waarde<sup>(1)</sup>: 675

<sup>(1)</sup>GWP = global warming potential (broeikaseffect)

Geregelde controles op koelmiddellekkages kunnen noodzakelijk zijn, navenant de Europese of plaatselijke wetgeving. Contacteer uw plaatselijke dealer voor nadere informatie.

# Veiligheidsmaatregelen

In deze handleiding worden de volgende symbolen gebruikt om u attent te maken op mogelijk gevaarlijke omstandigheden voor gebruikers, onderhoudspersoneel of het apparaat:

 <b>WAARSCHUWING</b>	Dit symbool verwijst naar een gevaar of onveilig gebruik dat kan resulteren in ernstig persoonlijk letsel of de dood.
 <b>LET OP</b>	Dit symbool verwijst naar een gevaar of onveilig gebruik dat kan resulteren in persoonlijk letsel of schade aan het product of andere eigendommen.

 Verboden	 Dingen waar u op moet letten
--	--

- Lees deze gebruiksinstructies zorgvuldig door voordat u de airconditioner gebruikt. Neem contact op met uw dealer als u nog steeds problemen hebt.
- Deze airconditioner is ontworpen om te zorgen voor aangename omstandigheden in uw kamer of andere ruimte. Gebruik het apparaat alleen waarvoor het is bedoeld en zoals is beschreven in deze gebruiksinstructies.

## WAARSCHUWING

 Raadpleeg uw erkende dealer of een bevoegd specialist omtrent het gebruik van het voorgeschreven koelmiddel. Het gebruik van een ander dan het voorgeschreven type kan schade aan de apparatuur, barsten en persoonlijk letsel enz. veroorzaken.

Deze airconditioner heeft geen ventilator voor de inlaat van frisse lucht van buiten. U moet regelmatig deuren of ramen open zetten als u in dezelfde ruimte gas- of olieverwarming gebruikt, want dit soort apparatuur verbruikt namelijk veel zuurstof uit de lucht.

Als u dat niet doet, loopt u in extreme gevallen risico op verstikking.

 Gebruik of bewaar nooit benzine of andere ontvlambare gassen of vloeistoffen in de buurt van de airconditioner - dit is zeer gevaarlijk.

Gebruik dit apparaat niet in een ruimte waar mogelijk explosiegevaar dreigt.

Raak de unit nooit met natte handen aan.

Steek uw vingers of andere voorwerpen niet in de binnen- of buitenunit van de airconditioner, want de draaiende delen kunnen letsel veroorzaken.





## WAARSCHUWING



Als het koelmiddel in contact komt met vuur, zal dit een giftig gas produceren.

Zorg er om veiligheidsredenen voor dat u de airconditioner uitschakelt en ook de stekker uit het stopcontact haalt voordat u het apparaat reinigt of onderhoud pleegt.

Trek in geval van nood de stekker van het netsnoer uit het stopcontact of schakel de stroomonderbreker uit, of schakel de hoofdschakelaar uit om de airconditioner volledig los te koppelen van de netstroom. 

Verwijderen in overeenstemming met landelijke en/of plaatselijke regelgeving.



Dit product mag in geen geval worden gewijzigd of gedemonteerd. Een gewijzigde of gedemonteerde unit kan leiden tot brand, elektrische schokken, of letsel.

Reinig nooit zelf het binnenste van de binnen- en buitenunits. Laat de reiniging uitvoeren door een bevoegde dealer of specialist.

Repareer bij storingen dit apparaat niet zelf. Neem voor reparatie en verwijdering contact op met uw dealer of reparateur.



Zorg voor een apart stopcontact dat uitsluitend bestemd is voor elk individueel toestel en een stroomonderbreker, aardlekschakelaar of verliesstroomschakelaar ter beveiliging tegen te hoge stromen in de uitsluitend voor de apparatuur bestemde stroomleiding.

Zorg voor een apart stopcontact voor elke unit en zorg ervoor dat conform de regelgeving voor elektrische bedrading er volledige ontkoppeling, dat wil zeggen een ontkoppeling van het stopcontact in alle polen, wordt geïmplementeerd in de vaste bedrading.

Ter voorkoming van mogelijke gevaren vanwege defecte isolatie moet de unit worden geaard. 



Gebruik geen aangepaste snoeren, snoeren die gedeeld worden met andere apparatuur, verlengsnoeren of snoeren die niet aan de specificaties voldoen om oververhitting en brand te vermijden.  



Het toestel moet worden bewaard in een ruimte waarin zich geen doorlopend werkende ontstekingsbronnen bevinden (bijvoorbeeld: open vuur, een werkend gasapparaat, of een werkend elektrisch verwarmingstoestel).

Let op, want koelmiddel kan geurloos zijn.

Een ongeventileerde plek waar een toestel dat gebruik maakt van ontvlambare koelmiddelen wordt geïnstalleerd, moet zo zijn geconstrueerd dat het koelmiddel in geval van een lekkage niet kan blijven staan zodat er brandgevaar en ontploffingsgevaar ontstaat.

Het toestel moet worden bewaard op een goed geventileerde plek en de afmetingen van de ruimte moeten overeenkomen met de afmetingen van de ruimte waarin het toestel volgens de specificaties gebruikt moet worden.

Nadat installatie van de unit bent u verplicht de installateur te vragen naar het vloeroppervlak van de ruimte waarin de unit is aangebracht en de hoeveelheid koelmiddel in het systeem.

Als de unit of de indeling van de ruimte wordt veranderd, bent u verplicht de dealer of servicevertegenwoordiger te raadplegen.



Gebruik geen andere middelen dan die worden aanbevolen door de fabrikant om het ontdooien sneller te laten verlopen of voor het reinigen.

Niet doorboren of verbranden.

In gevallen waarin mechanische ventilatie vereist is, moeten de ventilatie-openingen vrij van blokkeringen gehouden worden.



## WAARSCHUWING

 Het toestel moet worden bewaard in een ruimte zonder doorlopend open vuur (bijvoorbeeld: een werkend gasapparaat) en ontstekingsbronnen (bijvoorbeeld: een werkend elektrisch verwarmingstoestel).

 Stop met het gebruiken van het product wanneer er een abnormaliteit/storing optreedt en haal de stekker uit het stopcontact of schakel de stroomschakelaar en de stroomonderbreker uit. (Risico op rook/brand/elektrische schok)  
Voorbeelden van abnormale situaties/storingen:

- De aardlekschakelaar slaat vaak door.
- Het product start soms niet wanneer het wordt ingeschakeld.
- De stroomtoevoer wordt soms verbroken bij verplaatsing van het netsnoer.
- Als het apparaat in bedrijf is, ruikt u een verbrande geur of hoort u een abnormaal geluid.
- De behuizing is vervormd of abnormaal heet.
- Er lekt water uit de binnenunit.
- Stroomsnoer of stekker wordt abnormaal heet.
- Ventilatorsnelheid kan niet geregeld worden.
- De unit stopt onmiddellijk met werken, zelfs als deze ingeschakeld is om te werken.
- De ventilator stopt niet, zelfs niet als de unit stopt met werken.

Neem onmiddellijk contact op met uw plaatselijke dealer voor onderhoud/reparatie.

 Ga niet op de unit zitten of staan.  Als u dat wel doet, kunt u er vanaf vallen.

## AANKONDIGING

- Het toestel moet zo worden bewaard dat er geen mechanische schade kan optreden.
- Tijdens onweer kan de compressor soms stoppen. Dit is geen mechanische storing. De unit zal automatisch na enkele minuten weer opstarten.
- De Engelse tekst bevat de oorspronkelijke instructies. Tekst in andere talen is een vertaling van de oorspronkelijke instructies.

## LET OP

 Dit apparaat is bestemd voor gebruik door experts of geïnstrueerde gebruikers in winkels, in de lichte industrie of in agrarische bedrijven, alsmede voor commercieel gebruik door leken.

Dit toestel kan worden gebruikt door kinderen van 8 jaar en ouder en personen met verminderde fysieke, perceptuele of geestelijke vermogens of met een gebrek aan ervaring en kennis, mits zij onder toezicht staan of instructie hebben genoten aangaande het veilige gebruik van het toestel en mits zij de daaraan verbonden gevaren begrijpen. Kinderen mogen in geen geval met het apparaat spelen. Reiniging en door de gebruiker uit te voeren onderhoud mogen in geen geval gedaan worden door kinderen die niet onder toezicht staan.



Zorg voor een minimale afstand van 1,5 m tussen de unit en het brandalarm en de luchtuitlaat.

Zorg ervoor dat u de ruimte niet te veel koelt of verwarmt als er baby's of invalide personen aanwezig zijn.

 Schakel de airconditioner niet in en uit via de hoofdstroomschakelaar. Gebruik in plaats daarvan ON/OFF.

Steek geen voorwerpen in de luchtuitlaat van de buitenunit. Dit is gevaarlijk omdat de ventilator met hoge snelheid draait. 

Raak de luchtinlaat of de scherpe aluminium bladen van de buitenunit niet aan. Als u dat wel doet, kunt u letsel oplopen. 

Steek geen voorwerpen in de VENTILATORBEHUIZING.   Als u dat wel doet, kunt u letsel oplopen en kan de unit beschadigd raken.

# Voorzorgen in het gebruik

## Installatie

- We raden u aan deze airconditioner op de juiste wijze te laten installeren door bevoegde installatiemonteurs conform de installatie-instructies die u bij de unit hebt ontvangen.
- Controleer voor de installatie of het voltage van de stroomvoorziening in uw huis of kantoor overeenkomt met het voltage op het typeplaatje.



## WAARSCHUWING

### Vermijd de volgende locaties voor de installatie.

- Plekken met rook of ontvlambare gassen. Plekken met zeer hoge temperaturen, zoals broeikassen.
- Plekken met objecten die zeer veel warmte produceren.

### Attentie:

- Installeer de buitenunit niet op plekken waar er direct zout water op kan spetteren, of in de buurt van minerale bronnen met zwavelhoudende lucht. (Om de airconditioner te beschermen tegen ernstige roest.)

## Bedrading

- Alle bedrading moet voldoen aan de lokale elektriciteitsregelgeving. (Raadpleeg uw dealer of een bevoegd elektricien voor details.)
- Elke unit moet correct geaard zijn met een aardendraad of via de bedrading van de stroomtoevoer.
- De bedrading dient te worden aangelegd door een bevoegd elektricien.

## Vorbereiding voor gebruik

### Schakel de stroom in 5 uur voor u het apparaat wilt gaan gebruiken.

(Om het opwarmen mogelijk te maken.)

- Laat de stroom ingeschakeld (ON) staan voor continu gebruik.

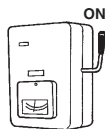

### OPMERKING

Trek de stekker van het netsnoer uit het stopcontact, of schakel de stroomonderbreker uit, of schakel de hoofdschakelaar uit om de airconditioner volledig los te koppelen van de netstroom als u het apparaat langere tijd niet gebruikt.

### Informatie voor gebruikers over inzamelen en verwijderen van oude apparatuur en gebruikte batterijen



Deze symbolen op de producten, verpakking en/of betekenen dat gebruikte elektrische en elektronische producten en batterijen niet gemengd mogen worden met het gewone huishoudelijke afval.

Breng voor een correcte behandeling, verwerking en recycling oude producten en gebruikte batterijen naar de daartoe aangewezen inzamelingspunten in overeenstemming met de nationale regelgeving op de betreffende locatie en de Richtlijnen 2002/96/EG en 2006/66/EG. Door deze producten en batterijen op de juiste manier te verwijderen helpt u waardevolle hulpbronnen te conserveren en mogelijke negatieve invloeden op de volksgezondheid en het milieu als gevolg van onjuiste afvalverwerking te voorkomen.

Voor meer informatie over het inzamelen en recyclen van oude producten en batterijen dient u contact op te nemen met uw gemeente, uw afvalverwerking of het verkooppunt waar u de items in kwestie gekocht hebt. In overeenstemming met de geldende regelgeving op uw locatie kunnen er sancties rusten op het incorrect verwijderen van dergelijk afval.

**Voor zakelijke gebruikers in de Europese Unie**  
Als u elektrische en elektronische apparatuur wilt verwijderen, dient u contact op te nemen met uw dealer of leverancier voor meer informatie.

### [Informatie over verwijdering in andere landen, buiten de Europese Unie]

Deze symbolen gelden alleen in de Europese Unie. Als u deze items wilt verwijderen, moet u contact opnemen met de plaatselijke autoriteiten en vragen hoe u dat moet doen.



### Opmerking batterijsymbool (onderschrift dient alleen als voorbeeld):

Dit symbool wordt mogelijk gebruikt in combinatie met een chemische aanduiding. In een dergelijk geval voldoet dit aan de eisen uit de Richtlijn met betrekking tot het chemische middel in kwestie.



# Namen van de onderdelen

## BUITENUNIT

### Enkele Splitsing

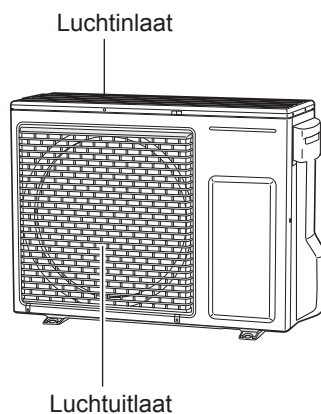

## Optioneel

### Draadloze afstandsbediening

Modelnr.  
CZ-RWS3



(Draadloze  
afstandsbediening)

Modelnr.  
CZ-RWSK2



### Draadloze timerafstandsbediening

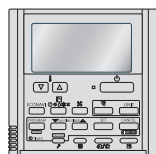

Modelnr.  
CZ-RTC4

Voor alle  
binnenunits

### Afstandsbediening met draad en hoge specificaties



Modelnr.  
CZ-RTC5B

Voor alle  
binnenunits

Lees de handleiding die wordt meegeleverd met de afstandsbediening.

### ■ Werking

Raadpleeg de gebruiksaanwijzing die aan de optionele afstandsbediening is bevestigd.

### ■ Richting van de luchtstroom aanpassen

Raadpleeg de gebruiksaanwijzingen die aan de binnenunit en de optionele afstandsbediening zijn bevestigd.

### ■ Onderhoud





Raadpleeg de gebruiksaanwijzing die aan de binnenunit is bevestigd.

### ■ Problemen oplossen

Raadpleeg de gebruiksaanwijzing die aan de binnenunit is bevestigd.

## Aanduidingen voor Richtlijn 2014/68/EU (PED)

Afbeelding naamplaatje met technische gegevens

<b>Panasonic</b>				0035
Air Conditioner		Model No. A: Model Name Various		
POWER SOURCE : B: Various				
MAX ELECTRIC INPUT C: kW A				
TIME DELAY FUSE MAX SIZE : D: A				
UNIT PROTECTION : IPX4				
Operating Spec. Area Various (Not for the PED)				
MAX.WORKING PRESSURE : HIGH SIDE E: bar ( MPa) Various LOW SIDE F: bar ( MPa) Various				
REFRIGERANT : R32 G: kg Various				
NET WEIGHT: Various (Not for the PED)				
SERIAL NO. : Various		PROD. DATE : YYYY.MM		
THE CAPACITY, CURRENT AND POWER INPUT ARE FOR THIS UNIT CONNECTED TO THE FOLLOWING INDOOR UNITS. Various (Not for the PED) FOR OTHER COMBINATIONS, REFER TO MANUAL.				
Authorized representative in EU Panasonic Testing Centre		Panasonic Marketing Europe GmbH Winsbergring 15, 22525 Hamburg, Germany		
Panasonic Corporation 1006 Kadoma, Kadoma City, Osaka, Japan				Made in Malaysia
    				
 THIS PRODUCT CONTAINS FLUORINATED GREENHOUSE GASES R 3 2 GWP=6 7 5 Various				

Tabel met diverse gegevens

A	U-36PZH2E5	U-50PZH2E5	U-60PZH2E5
B	220 - 230 - 240 V~ 50 Hz		
C	2,40 kW, 11,0 A	2,68 kW, 12,0 A	3,54 kW, 16,4 A
D	20 A	20 A	25 A
E	41,5 bar (4,15 MPa)		
F	27,0 bar (2,70 MPa)		
G	1,15 kg	1,15 kg	1,45 kg

A	U-60PZ2E5	U-71PZ2E5
B	220 - 230 - 240 V~ 50 Hz	
C	3,54 kW, 16,4 A	3,54 kW, 16,4 A
D	25 A	25 A
E	41,5 bar (4,15 MPa)	
F	25,5 bar (2,55 MPa)	
G	1,45 kg	1,45 kg



Obrigado por adquirir este produto Panasonic.  
Este produto é uma unidade interior para aparelho de ar condicionado comercial.  
As instruções de instalação estão anexadas.

# Índice

- **Precauções de segurança**..... 38
- **Precauções de utilização** ..... 41
- **Nomenclatura das peças**..... 42

---

- **Especificações** ..... 62
  - **Unidade exterior** ..... 62
  - **Tabela dos idiomas correspondentes** ..... 62

	<b>ADVERTÊNCIA</b>	Este símbolo mostra que este equipamento utiliza um refrigerante inflamável. No caso de fuga do refrigerante num ambiente com uma fonte de ignição externa, existe a possibilidade de inflamação do refrigerante.
	<b>PRECAUÇÃO</b>	Este símbolo mostra que pessoal de assistência deve manusear este equipamento com referência ao Manual técnico.
	<b>PRECAUÇÃO</b>	Este símbolo mostra que existem informações nas Instruções de operação e/ou Instruções de instalação.

## Informações sobre o produto

Se tem alguma questão ou problema respeitante ao seu aparelho de ar condicionado, vai necessitar da informação que se segue. O modelo e os números de série estão localizados na placa de identificação.

Nº do modelo
Nº de série
Data da compra
Endereço do revendedor
Telefone

### Informação importante sobre o refrigerante utilizado

Este produto contém gases fluorados com efeito de estufa. Não ventile os gases para a atmosfera.

Tipo de refrigerante: R32



Valor GWP<sup>(1)</sup>: 675

<sup>(1)</sup>GWP = global warming potential (Potencial de aquecimento global)

Pode ser necessário efectuar inspecções periódicas para detectar fugas de refrigerante dependendo da legislação Europeia ou local. Contacte o revendedor local para obter mais informações.

# Precauções de segurança

Os símbolos que se seguem são utilizados neste manual de instruções para o alertar sobre condições potencialmente perigosas para os utilizadores, pessoal de manutenção ou o próprio aparelho:

	<b>ADVERTÊNCIA</b>	Este símbolo refere-se a um perigo ou mau manuseamento que pode resultar em ferimentos pessoais severos ou morte.
	<b>PRECAUÇÃO</b>	Este símbolo refere-se a um perigo ou mau manuseamento que pode resultar em ferimentos pessoais, danos ao produto ou aos objectos que o cercam.

	Itens proibidos		Pontos a serem observados
---	-----------------	---	---------------------------

- Leia este manual de instruções cuidadosamente antes de utilizar este aparelho de ar condicionado. Se ainda tiver algumas dificuldades ou problemas consulte o seu revendedor.
- Este aparelho tem por finalidade oferecer-lhe condições confortáveis na sala. Utilize-o apenas para esse fim como descrito neste manual de instruções.

## ! ADVERTÊNCIA



Consulte um revendedor autorizado ou especialista sobre o tipo de refrigerante especificado a ser utilizado. A utilização de um refrigerante diferente do especificado pode danificar o produto, provocar explosões e ferimentos, etc.

---

Este aparelho de ar condicionado não tem ventilador para retirar ar fresco do exterior. Deve abrir frequentemente portas e janelas quando utiliza aquecimentos a gás ou óleo na mesma sala, pois estes consomem grande quantidade de oxigénio do ar. De outra maneira, em casos extremos, podem ocorrer casos de sufocação.

---



Nunca utilize ou armazene gasolina ou outros vapores ou líquidos inflamáveis perto do aparelho de ar condicionado — é muito perigoso.

---

Não utilize este aparelho em um ambiente propenso a explosão.

---

Não toque na unidade com as mãos molhadas.

---

Não introduza os dedos nem outros objectos na unidade interior ou exterior do aparelho de ar condicionado, pois as peças móveis podem provocar lesões. 

## ADVERTÊNCIA

 Se o refrigerante entrar em contacto com uma chama, ele produzirá um gás tóxico.

Por razões de segurança, certifique-se de que desliga o aparelho de ar condicionado e a corrente eléctrica antes da limpeza ou da assistência.

Em caso de emergência, desligue a ficha eléctrica da tomada ou desligue o disjuntor ou o interruptor eléctrico para isolar o aparelho de ar condicionado da fonte de alimentação. 

Elimine de acordo com a legislação nacional e/ou local.

 Este produto não deve ser modificado ou desmontado em nenhuma hipótese. Uma unidade desmontada ou modificada pode causar incêndio, choque eléctrico ou ferimento.



Os utilizadores não devem limpar o interior das unidades exteriores e interiores. A limpeza deve ser realizada por um especialista ou um revendedor autorizado.

Em caso de avaria deste aparelho, não o repare sozinho. Entre em contacto com o distribuidor ou o representante de assistência para efectuar uma reparação e eliminação.

 Providencie uma tomada eléctrica para ser utilizada exclusivamente para cada unidade, bem como um interruptor para a fonte de energia, um disjuntor de fugas de ligação à terra (ELCB) ou um dispositivo de corrente residual (RCD) para protecção de sobrecorrente na linha exclusiva.

Providencie uma tomada eléctrica exclusivamente para cada unidade e integrar meios de desactivação total com separação de contacto em todos os pólos da instalação eléctrica fixa, conforme as normas de fiação.

Para impedir possíveis perigos devido a falha do isolamento, tem de ligar a unidade à massa. 

 De modo a evitar o sobreaquecimento e incêndios, não utilize cabos modificados, cabos partilhados, extensões eléctricas nem cabos não especificados.  

 O aparelho deve ser armazenado em uma sala sem fontes de ignição em funcionamento contínuo (por exemplo: chamas abertas, aparelho de gás em funcionamento ou um aquecedor eléctrico em funcionamento).

Tenha em mente que os refrigerantes podem ser inodoros.

Uma área sem ventilação, na qual seja instalado um aparelho que utilize refrigerantes inflamáveis, deve ser construída de forma que qualquer fuga do refrigerante não fique confinada no ambiente, pois isso criaria um perigo de incêndio ou explosão.

O aparelho deverá ser armazenado em uma área bem ventilada em que o tamanho da sala corresponda à área da sala conforme especificado para o funcionamento.

Depois de instalar a unidade, certifique-se de que pergunta ao instalador sobre o espaço do piso da sala onde a unidade está instalada e sobre a quantidade de carga do refrigerante.

No caso de mudança da unidade ou de um divisor da sala, certifique-se de que consulta o representante de vendas ou representante de assistência técnica.

 Não utilize meios para acelerar o processo de descongelamento ou para limpar que não sejam os meios recomendados pelo fabricante.

Não perfure nem queime.

No casos em que se necessite ventilação mecânica, as aberturas de ventilação devem ser mantidas sem obstruções.

## ADVERTÊNCIA

 O aparelho deve ser armazenado em uma sala sem chamas abertas (por exemplo: um aparelho de gás em funcionamento) e fontes de ignição em funcionamento contínuo (por exemplo: um aquecedor eléctrico em funcionamento).

 Numa situação de anomalia/avaria do produto, interrompa o seu uso e retire a ficha da tomada ou e o disjuntor.  
(Risco de fumo/incêndio/choque eléctrico)

Exemplos de anormalidade/avaria:

- O ELCB dispara frequentemente.
- O produto não arranca por vezes quando está ligado.
- A corrente desliga-se por vezes quando move o cabo.
- Odor a queimado ou ruído anormal é detectado durante o funcionamento.
- O chassis está deformado ou anormalmente quente.
- Fugas de água da unidade interior.
- Sobreaquecimento do cabo de alimentação ou da ficha.
- Não é possível controlar a velocidade da ventoinha.
- A unidade desliga-se imediatamente após ser activada.
- A ventoinha não pára mesmo após a unidade ser desligada.

Contacte imediatamente o revendedor local para manutenção/reparação.

 Não se sente nem suba para cima da unidade. Pode cair acidentalmente.



## PRECAUÇÃO

 Este equipamento pretende ser usado por peritos ou utilizadores com formação em lojas, na indústria leve e em quintas, ou para utilização comercial por pessoas não especializadas.

Este aparelho pode ser utilizado por crianças acima de 8 anos de idade e por pessoas com deficiências físicas, sensoriais ou mentais, ou com falta de experiência e conhecimento, desde que sejam supervisionados ou instruídos sobre a utilização do aparelho de maneira segura e desde que compreendam os perigos envolvidos. Crianças não devem brincar com o aparelho. A limpeza e manutenção pelo utilizador não devem ser realizadas por crianças sem supervisão.

Mantenha o alarme de incêndio e a saída de ar a pelo menos 1,5 m da unidade.

Não arrefeça ou aqueça demasiado a sala quando estiverem presentes bebés ou pessoas inválidas.

 Não ligue e desligue o aparelho de ar condicionado utilizando o interruptor principal. Utilize o botão de operação ON/OFF.

Não coloque nada na saída de ar da unidade exterior. É muito perigoso devido à alta velocidade de rotação do ventilador.



Não toque na entrada de ar ou nas pás de alumínio afiadas da unidade exterior. Pode sofrer ferimentos.



Não cole nenhum objecto na CAIXA DA VENTONHA. Pode sofrer ferimentos e danificar a unidade.



### AVISO

- O aparelho deve ser armazenado de forma a prevenir a ocorrência de danos mecânicos.
- O compressor pode parar ocasionalmente durante tempestades com trovoadas ou relâmpagos. Isso não é falha mecânica. A unidade é restabelecida automaticamente depois de alguns minutos.
- As instruções foram redigidas originalmente em inglês. As versões noutras línguas são traduções da redacção original.



# Precauções de utilização

## Instalação

- Este aparelho de ar condicionado deve ser instalado adequadamente por um técnico de instalação qualificado de acordo com as Instruções de Instalação fornecidas com o aparelho.
- Antes da instalação deste aparelho de ar condicionado, verifique se a voltagem da rede local na sua casa ou escritório é a mesma que a voltagem indicada na placa identificadora.



## ADVERTÊNCIA

### Evite as seguintes localizações para a instalação.

- Localizações onde existe fumo ou combustível. Localizações de temperatura extremamente alta como em uma estufa.
- Localizações em que haja dispositivos que geram calor excessivo.

### Atenção:

- Evite instalar a unidade exterior onde possa ser atingida por água do mar ou perto de ar sulfuroso de termas. (Para proteger o aparelho de ar condicionado de alta corrosão)

## Ligações

- Todas as ligações devem estar de acordo com os requisitos eléctricos locais. (Consulte o seu revendedor ou um electricista qualificado para mais detalhes.)
- Cada unidade deve ser adequadamente ligada à terra mediante um fio de terra ou as ligações fornecidas.
- As ligações devem ser feitas por um electricista qualificado.

## Preparação para a operação

### Ligue o aparelho à corrente eléctrica 5 horas antes da operação inicial.

(Para aquecimento)

- Deixe a corrente eléctrica ligada para utilização contínua.



### NOTA

Se não for utilizar o aparelho por um longo tempo, desligue a ficha eléctrica da tomada ou desligue o disjuntor ou o interruptor eléctrico para isolar o aparelho de ar condicionado da fonte de alimentação.

### Informações para utilizadores sobre a recolha e eliminação de equipamentos velhos e pilhas usadas



Estes símbolos nos produtos, embalagem e/ou documentos acompanhantes significam que os produtos eléctricos e electrónicos velhos e pilhas usadas não devem ser misturados com o lixo doméstico geral.

Para o tratamento, recuperação e reciclagem de produtos velhos e pilhas usadas de maneira apropriada, leve-os aos pontos de recolha aplicáveis de acordo com a legislação nacional do seu país e com as Directivas 2002/96/CE e 2006/66/CE.

Mediante a eliminação correcta destes produtos e pilhas, ajudará a salvar recursos valiosos e prevenir efeitos negativos potenciais sobre a saúde humana e o meio ambiente, que poderiam decorrer do manuseio de resíduos inadequado.

Para mais informações sobre a recolha e reciclagem de produtos velhos e pilhas usadas, contacte a autarquia local, o serviço de eliminação de resíduos ou o ponto de venda de onde comprou os itens.

Poderão ser aplicadas penalidades em caso de eliminação indevida de lixo de acordo com a legislação nacional.

### Para utilizadores comerciais na União Europeia

Se quiser eliminar algum equipamento eléctrico ou electrónico, contacte o seu revendedor ou distribuidor para mais informações.

### [Informações sobre a eliminação em outros países fora da União Europeia]

Estes símbolos são válidos apenas na União Europeia. Se quiser eliminar estes itens, contacte a autoridade local ou o seu revendedor e informe-se sobre o método de eliminação correcto.



### Nota para os símbolos de pilha (dois exemplos inferiores):

Este símbolo pode ser utilizado em combinação com um símbolo químico. Neste caso, ele satisfaz os requisitos estipulados pela Directiva para o elemento químico envolvido.



Pb

# Nomenclatura das peças

## UNIDADE EXTERIOR

### Single Split

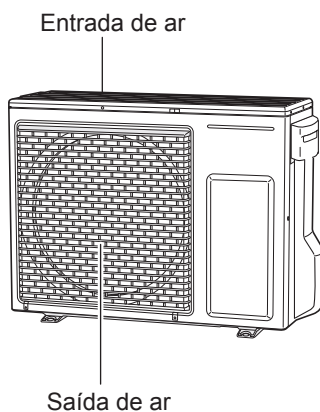

### Opcional

#### Controlo remoto sem fios

Nº do modelo  
CZ-RWS3



(Controlador  
remoto sem fio)

Nº do modelo  
CZ-RWSK2



#### Controlo remoto do temporizador

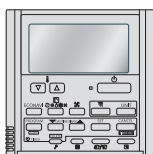

Nº do modelo  
CZ-RTC4

Para todas as  
unidades interiores

#### Telecomando com fios de alta especificação



Nº do modelo  
CZ-RTC5B

Para todas as  
unidades interiores

Leia as instruções de operação incluídas com o telecomando.

#### ■ Utilização

Consulte as instruções de operação que acompanham no telecomando opcional.

#### ■ Ajustar a direcção de caudal de ar

Consulte as instruções de operação que acompanham a unidade interior e o telecomando opcional.

#### ■ Manutenção







Consulte as instruções de operação que acompanham na unidade interior.

#### ■ Resolução de problemas

Consulte as instruções de operação que acompanham na unidade interior.

## Marcações para a Directiva 2014/68/EU (PED)

Figura da placa de identificação dos valores nominais

<b>Panasonic</b>				0035
Air Conditioner		<b>Model No.</b> A: Model Name Various		
POWER SOURCE : B: Various				
MAX ELECTRIC INPUT : C: kW A				
TIME DELAY FUSE MAX SIZE : D: A				
UNIT PROTECTION : IPX4				
Operating Spec. Area Various (Not for the PED)				
MAX.WORKING PRESSURE : HIGH SIDE E: bar ( MPa) Various LOW SIDE F: bar ( MPa) Various				
REFRIGERANT : R32 G: kg Various				
NET WEIGHT: Various (Not for the PED)				
SERIAL NO. : Various		PROD. DATE : YYYY.MM		
THE CAPACITY, CURRENT AND POWER INPUT ARE FOR THIS UNIT CONNECTED TO THE FOLLOWING INDOOR UNITS. Various (Not for the PED) FOR OTHER COMBINATIONS, REFER TO MANUAL.				
Authorized representative in EU Panasonic Testing Centre		Panasonic Marketing Europe GmbH Winsbergring 15, 22525 Hamburg, Germany		
Panasonic Corporation 1006 Kadoma, Kadoma City, Osaka, Japan				Made in Malaysia
<b>R32</b>    				
 THIS PRODUCT CONTAINS FLUORINATED GREENHOUSE GASES R 3 2 GWP=6 7 5				
Various				

### Tabulação dos dados Vários

A	U-36PZH2E5	U-50PZH2E5	U-60PZH2E5
B	220 - 230 - 240 V~ 50 Hz		
C	2,40 kW, 11,0 A	2,68 kW, 12,0 A	3,54 kW, 16,4 A
D	20 A	20 A	25 A
E	41,5 bar (4,15 MPa)		
F	27,0 bar (2,70 MPa)		
G	1,15 kg	1,15 kg	1,45 kg

A	U-60PZ2E5	U-71PZ2E5
B	220 - 230 - 240 V~ 50 Hz	
C	3,54 kW, 16,4 A	3,54 kW, 16,4 A
D	25 A	25 A
E	41,5 bar (4,15 MPa)	
F	25,5 bar (2,55 MPa)	
G	1,45 kg	1,45 kg



Σας ευχαριστούμε που αγοράσατε αυτό το προϊόν της Panasonic.

Αυτό το προϊόν είναι μια εμπορική εσωτερική μονάδα κλιματιστικού.

Επισυνάπτονται οδηγίες εγκατάστασης.

# Περιεχόμενα

- Προφυλάξεις ασφάλειας..... 44
- Προφυλάξεις για χρήση..... 47
- Ονόματα μερών..... 48
- Προδιαγραφές..... 62
  - Εξωτερική μονάδα..... 62
  - Πίνακας με τις αντίστοιχες γλώσσες..... 62

 ΠΡΟΕΙΔΟΠΟΙΗΣΗ	Το σύμβολο αυτό δείχνει ότι αυτός ο εξοπλισμός χρησιμοποιεί ένα εύφλεκτο ψυκτικό. Αν το ψυκτικό διαρρέει και υπάρχει μια εξωτερική πηγή ανάφλεξης, υπάρχει πιθανότητα ανάφλεξης.
 ΠΡΟΣΟΧΗ	Αυτό το σύμβολο δείχνει ότι ένα μέλος του προσωπικού συντήρησης θα πρέπει να χειριστεί αυτόν τον εξοπλισμό σύμφωνα με το Τεχνικό Εγχειρίδιο.
 ΠΡΟΣΟΧΗ	Το σύμβολο αυτό δείχνει ότι περιλαμβάνονται πληροφορίες στις Οδηγίες λειτουργίας ή/και Οδηγίες εγκατάστασης.

## Πληροφορίες για το προϊόν

Αν έχετε προβλήματα ή απορίες σχετικά με το κλιματιστικό σας, θα χρειαστείτε τις παρακάτω πληροφορίες. Το μοντέλο και οι σειριακοί αριθμοί αναγράφονται στην πινακίδα ονομασίας.

Αρ. μοντέλου

Αύξων αριθμός

Ημερομηνία αγοράς

Διεύθυνση αντιπροσώπου

Τηλέφωνο

## Σημαντικές πληροφορίες πάνω στο χρησιμοποιούμενο ψυκτικό

Αυτό το προϊόν περιέχει φθοριούχα αέρια θερμοκηπίου. Μην αερίζετε τα αέρια στην ατμόσφαιρα.

Τύπος ψυκτικού: R32



Τιμή GWP<sup>(1)</sup>: 675

<sup>(1)</sup>GWP = global warming potential (δυναμικό θέρμανσης του πλανήτη)

Περιοδικές απαιτήσεις για τυχόν διαρροές του ψυκτικού μπορεί να απαιτηθούν ανάλογα με την ευρωπαϊκή ή τη τοπική νομοθεσία. Παρακαλείστε να έρθετε σε επαφή με τον τοπικό σας αντιπρόσωπο για περισσότερες πληροφορίες.

# Προφυλάξεις ασφάλειας

Τα παρακάτω σύμβολα που χρησιμοποιούνται σε αυτό το εγχειρίδιο σας προειδοποιούν για ενδεχόμενες επικίνδυνες καταστάσεις για τους χρήστες, το προσωπικό επισκευής ή το μηχάνημα:

 ΠΡΟΕΙΔΟΠΟΙΗΣΗ	Αυτό το σύμβολο αναφέρεται σε μια επικίνδυνη ή μη ασφαλή ενέργεια που μπορεί να οδηγήσει σε σοβαρό προσωπικό τραυματισμό ή θάνατο.
 ΠΡΟΣΟΧΗ	Αυτό το σύμβολο αναφέρεται σε μια επικίνδυνη ή μη ασφαλή ενέργεια που μπορεί να οδηγήσει σε προσωπικό τραυματισμό ή ζημιά του προϊόντος ή της περιουσίας σας.

 Θέματα που απαγορεύονται	 Θέματα που πρέπει να προσέξετε
--	--

- Διαβάστε προσεκτικά τις παρούσες Οδηγίες χρήσης πριν χρησιμοποιήσετε αυτό το κλιματιστικό. Αν έχετε οποιεσδήποτε δυσκολίες ή προβλήματα, συμβουλευθείτε τον αντιπρόσωπό σας για βοήθεια.
- Αυτό το κλιματιστικό έχει σχεδιαστεί για να σας παρέχει άνετες συνθήκες δωματίου. Χρησιμοποιήστε το μόνο για το σκοπό που προορίζεται, όπως περιγράφεται στις παρούσες Οδηγίες χρήσης.

## ΠΡΟΕΙΔΟΠΟΙΗΣΗ



Επιβεβαιώστε με τον εξουσιοδοτημένο αντιπρόσωπο ή ειδικό για τη χρήση του καθορισμένου τύπου ψυκτικού. Η χρήση ψυκτικού διαφορετικού από τον καθορισμένο τύπο μπορεί να προκαλέσει βλάβη στο προϊόν, έκρηξη και τραυματισμό, κτλ.

Αυτό το κλιματιστικό δεν έχει εξαιρεστήρα για να παίρνει καθαρό αέρα από έξω. Κάθε φορά που χρησιμοποιείτε συσκευές θέρμανσης με υγραέριο ή πετρέλαιο στο ίδιο δωμάτιο, πρέπει να ανοίγετε συχνά τις πόρτες και τα παράθυρα επειδή καταναλώνουν πολύ από το οξυγόνο του αέρα.

Διαφορετικά, σε έσχατη περίπτωση, υπάρχει κίνδυνος ασφυξίας.



Ποτέ μη χρησιμοποιείτε, ούτε να αποθηκεύετε, βενζίνη ή άλλο εύφλεκτο αέριο ή υγρό κοντά στο κλιματιστικό. Είναι πολύ επικίνδυνο.

Μην χρησιμοποιείτε αυτή τη συσκευή σε δυνητικά εκρηκτικές ατμόσφαιρες.

Μην αγγίζετε ποτέ τη συσκευή με βρεγμένα χέρια.

Μην τοποθετείτε τα δάχτυλά σας ή άλλα αντικείμενα στην εσωτερική ή εξωτερική μονάδα του κλιματιστικού, τα περιστρεφόμενα μέρη ενδέχεται να προκαλέσουν τραυματισμό.



## ΠΡΟΕΙΔΟΠΟΙΗΣΗ

 Αν το ψυκτικό έρθει σε επαφή με φωτιά, παράγει τοξικό αέριο.

Για λόγους ασφάλειας, βεβαιωθείτε ότι έχετε σβήσει το κλιματιστικό καθώς επίσης ότι έχετε αποσυνδέσει την τροφοδοσία ρεύματος πριν τον καθαρισμό ή το σέρβις.

Σε περίπτωση έκτακτης ανάγκης, αποσυνδέστε το βύσμα ηλεκτρικής παροχής από την πρίζα, κατεβάστε την ασφάλεια ή απενεργοποιήστε το διακόπτη ισχύος, ώστε να απομονώσετε το κλιματιστικό από την κεντρική παροχή.



Διαθέστε σύμφωνα με την εθνική ή/και τοπική νομοθεσία.

 Αυτό το προϊόν, σε καμία περίπτωση, δεν πρέπει να τροποποιηθεί ή να αποσυναρμολογηθεί. Η τροποποίηση ή η αποσυναρμολόγηση της μονάδας μπορεί να προκαλέσει πυρκαγιά, ηλεκτροπληξία ή τραυματισμό.



Ο καθαρισμός του εσωτερικού των εσωτερικών και εξωτερικών μονάδων δεν πρέπει να πραγματοποιείται από τους χρήστες. Καλέστε εξουσιοδοτημένο αντιπρόσωπο ή ειδικό για τον καθαρισμό.

Σε περίπτωση δυσλειτουργίας αυτής της συσκευής, μην την επισκευάσετε μόνοι σας. Επικοινωνήστε με τον αντιπρόσωπο πωλήσεων ή τον αντιπρόσωπο συντήρησης για την επισκευή και διάθεση.

 Παρέχετε ηλεκτρική πρίζα που θα χρησιμοποιείται αποκλειστικά για κάθε μονάδα, ενώ στην αποκλειστική γραμμή θα πρέπει να παρέχετε διακόπτη ηλεκτρικής παροχής, ασφάλεια κυκλώματος διαρροής γείωσης (ELCB) ή διάταξη προστασίας ρεύματος διαρροής (RCD) για προστασία από την υπερένταση.

Να έχετε μια πρίζα που θα χρησιμοποιείτε αποκλειστικά για κάθε μονάδα. Στη μόνιμη καλωδίωση, απαιτείται να ενσωματωθεί διάταξη πλήρους αποσύνδεσης με δυνατότητα διαχωρισμού επαφών σε όλους τους πόλους σύμφωνα τους κανόνες κατασκευής καλωδιώσεων.

Για την πρόληψη πιθανών κινδύνων από βλάβη της μόνωσης, η μονάδα  πρέπει να γειώνεται.

 Για την αποτροπή υπερθέρμανσης και πυρκαγιάς, μην χρησιμοποιείτε τροποποιημένα καλώδια, καλώδια συναρμογής, καλώδια επέκτασης ή μη ειδικά καλώδια.  

 Η συσκευή πρέπει να αποθηκεύεται σε ένα δωμάτιο χωρίς πηγές ανάφλεξης που λειτουργούν συνεχόμενα (για παράδειγμα: γυμνές φλόγες, συσκευή αερίου σε λειτουργία ή ηλεκτρικό θερμαντήρα σε λειτουργία).

Να γνωρίζετε ότι τα ψυκτικά μπορεί να μην περιέχουν πρόσθετο οσμής.

Μια μη αεριζόμενη περιοχή στην οποία έχει εγκατασταθεί μια συσκευή που χρησιμοποιεί εύφλεκτα ψυκτικά θα πρέπει να κατασκευαστεί με τρόπο ώστε να μην συσσωρεύεται τυχόν διαρροή ψυκτικού για να δημιουργηθεί κίνδυνος πυρκαγιάς ή έκρηξης.

Η συσκευή πρέπει να αποθηκεύεται σε μια καλά αεριζόμενη περιοχή όπου το μέγεθος δωματίου αντιστοιχεί στην περιοχή δωματίου όπως καθορίζεται για τη λειτουργία.

Αφού εγκατασταθεί η μονάδα, μην ξεχάσετε να ρωτήσετε τον τεχνικό της εγκατάστασης το εμβαδόν του δαπέδου του χώρου εγκατάστασης της μονάδας και της ποσότητας φόρτισης αντιψυκτικού.

Σε περίπτωση αλλαγής της μονάδας ή του διαχωριστικού του δωματίου, μην ξεχνάτε ποτέ τον αντιπρόσωπο πωλήσεων ή το τμήμα σέρβις.

 Μην χρησιμοποιείτε μέσα για την επιτάχυνση της διαδικασίας απόψυξης ή για τον καθαρισμό, διαφορετικά από αυτά που συνιστά ο κατασκευαστής.

Μην διατρυπάτε και μην καίτε.

Σε περιπτώσεις που απαιτούν μηχανικό εξαιρισμό, τα ανοίγματα αερισμού θα πρέπει μην εμφανίζουν εμπόδια.

## ΠΡΟΕΙΔΟΠΟΙΗΣΗ



Η συσκευή πρέπει να αποθηκεύεται σε ένα δωμάτιο χωρίς συσκευές με γυμνές φλόγες που λειτουργούν συνεχόμενα (για παράδειγμα: μια συσκευή αερίου σε λειτουργία) ή πηγές ανάφλεξης (για παράδειγμα: έναν ηλεκτρικό θερμαντήρα σε λειτουργία).



Διακόψτε τη χρήση του προϊόντος αν παρουσιαστεί οποιαδήποτε ανωμαλία/βλάβη και αποσυνδέστε το βύσμα του ρεύματος ή κλείστε το διακόπτη τροφοδοσίας και την ασφάλεια. (Υπάρχει κίνδυνος καπνού/πυρκαγιάς/ηλεκτροπληξίας)

Παραδείγματα ανωμαλίας/αστοχίας:

- Ο διακόπτης κυκλώματος διαρροής της γείωσης (ELCB) ενεργοποιείται συχνά.
- Μερικές φορές, το προϊόν δεν ξεκινά όταν το ενεργοποιείτε.
- Μερικές φορές, η ισχύς αποσυνδέεται όταν κινείται το καλώδιο.
- Υπάρχει οσμή καμένου ή ασυνήθιστος θόρυβος κατά τη λειτουργία.
- Το κυρίως τμήμα είναι παραμορφωμένο ή ασυνήθιστα ζεστό.
- Υπάρχει διαρροή νερού από την εσωτερική μονάδα.
- Το καλώδιο ή το βύσμα ρεύματος είναι υπερβολικά ζεστό.
- Δεν είναι εφικτός ο έλεγχος της ταχύτητας του ανεμιστήρα.
- Η λειτουργία της μονάδας διακόπτεται αμέσως, ακόμη και αν έχει τεθεί σε λειτουργία.
- Ο ανεμιστήρας δεν σταματάει ακόμη και αν έχει διακοπεί η λειτουργία.

Επικοινωνήστε αμέσως με τον τοπικό σας αντιπρόσωπο για συντήρηση/επισκευή.



Μην κάθεστε και μην στέκεστε επάνω στη μονάδα. Μπορεί να πέσετε κάτω κατά λάθος.



## ΠΡΟΣΟΧΗ



Η συσκευή αυτή προορίζεται για χρήση από ειδικούς ή εκπαιδευμένους χρήστες σε καταστήματα, στην ελαφρά βιομηχανία και σε αγροκτήματα, ή για εμπορική χρήση από μη ειδικευμένα άτομα.

Αυτή η συσκευή μπορεί να χρησιμοποιηθεί από παιδιά από 8 ετών και πάνω και άτομα με μειωμένες σωματικές, αισθητήριες ή νοητικές ικανότητες ή έλλειψη εμπειρίας και γνώσεων εάν τους έχει παρασχεθεί επίβλεψη ή καθοδήγηση σχετικά με την ασφαλή χρήση της συσκευής, και κατανοούν τους κινδύνους που εμπλέκονται. Τα παιδιά δεν επιτρέπεται να παίζουν με τη συσκευή. Οι εργασίες καθαρισμού και συντήρησης δεν πρέπει να γίνονται από παιδιά, χωρίς την επίβλεψή τους.

Διατηρείτε το συναγερμό πυρκαγιάς και την έξοδο αέρα τουλάχιστον 1,5 m μακριά από τη μονάδα.

Η θερμοκρασία ενός δωματίου όπου βρίσκονται μωρά ή ηλικιωμένοι δεν πρέπει να είναι υπερβολικά χαμηλή ή υψηλή.



Μην ανοιγοκλείνετε το κλιματιστικό από τον κεντρικό διακόπτη τροφοδοσίας. Χρησιμοποιήστε το κουμπί λειτουργίας ON/OFF.

Μη τοποθετείτε τίποτα στην έξοδο αέρα της εξωτερικής μονάδας. Αυτό είναι επικίνδυνο επειδή ο ανεμιστήρας περιστρέφεται με μεγάλη ταχύτητα.



Μην αγγίζετε την είσοδο αέρα ή τα αιχμηρά πτερύγια αλουμινίου της εξωτερικής μονάδας. Μπορεί να τραυματιστείτε.



Μην τοποθετείτε κανένα αντικείμενο στη ΘΗΚΗ ΑΝΕΜΙΣΤΗΡΑ. Μπορεί να τραυματιστείτε και η μονάδα μπορεί να υποστεί βλάβη.



## ΑΝΑΚΟΙΝΩΣΗ

- Η συσκευή θα πρέπει να αποθηκευτεί ώστε να αποφεύγεται η μηχανική ζημιά.
- Η λειτουργία του συμπιεστή ενδέχεται να διακόπτεται περιστασιακά στη διάρκεια καταιγίδων. Δεν πρόκειται για μηχανική αστοχία. Η δυνατότητα λειτουργίας της μονάδας επανέρχεται αυτόματα μετά από μερικά λεπτά.
- Το αγγλικό κείμενο είναι οι πρωτότυπες οδηγίες. Οι άλλες γλώσσες είναι μεταφράσεις των πρωτότυπων οδηγιών.

# Προφυλάξεις για χρήση

## Εγκατάσταση

- Η εγκατάσταση αυτού του κλιματιστικού πρέπει να γίνει σωστά από ειδικευμένους τεχνικούς εγκατάστασης σύμφωνα με τις οδηγίες εγκατάστασης που συνοδεύουν τη μονάδα.
- Πριν από την εγκατάσταση, βεβαιωθείτε ότι η τάση του ηλεκτρικού ρεύματος στο σπίτι ή στο γραφείο σας είναι η ίδια με την τάση που αναγράφεται στην πινακίδα.



## ΠΡΟΕΙΔΟΠΟΙΗΣΗ

### Αποφεύγετε τις παρακάτω τοποθεσίες για την εγκατάσταση.

- Τοποθεσίες όπου υπάρχει καπνός ή εύφλεκτα αέρια. Επίσης τοποθεσίες με εξαιρετικά υψηλή θερμοκρασία όπως ένα θερμοκήπιο.
- Τοποθεσίες όπου βρίσκονται αντικείμενα που παράγουν μεγάλες ποσότητες θερμότητας.

### Προσοχή:

- Αποφύγετε την εγκατάσταση της εξωτερικής μονάδας σε μέρη όπου αυτή μπορεί να έρθει σε άμεση επαφή με θαλασσινό νερό ή κοντά σε πηγές θειούχων αερίων σε ιαματικά λουτρά. (Για να προστατέψετε το κλιματιστικό από διάβρωση μεγάλου βαθμού)

## Καλωδίωση

- Όλες οι καλωδιώσεις πρέπει να συμμορφώνονται με τους τοπικούς κανονισμούς για την ηλεκτρολογία. (Συμβουλευθείτε τον αντιπρόσωπό σας ή έναν ειδικευμένο ηλεκτρολόγο για λεπτομέρειες.)
- Κάθε μονάδα πρέπει να είναι γειωμένη με ένα καλώδιο γείωσης ή μέσω των σωληνώσεων ύδρευσης.
- Οι καλωδιώσεις πρέπει να γίνουν από έναν ειδικευμένο ηλεκτρολόγο.

## Προετοιμασία λειτουργίας

### Ενεργοποιήστε την κεντρική ηλεκτρική παροχή 5 ώρες πριν την έναρξη της λειτουργίας.

(Για προθέρμανση)

- Αφήστε την κεντρική ηλεκτρική παροχή στην ενεργή θέση (ON) για συνεχόμενη χρήση.



### ΠΑΡΑΤΗΡΗΣΗ

Όταν δεν χρησιμοποιείτε τη συσκευή για μεγάλο χρονικό διάστημα, αποσυνδέστε το βύσμα ηλεκτρικής παροχής από την πρίζα, κατεβάστε την ασφάλεια ή απενεργοποιήστε το διακόπτη ισχύος, ώστε να απομονώσετε το κλιματιστικό από την κεντρική παροχή.

### Πληροφορίες για τους χρήστες σχετικά με τη συλλογή και απόρριψη παλιού εξοπλισμού και χρησιμοποιημένων μπαταριών



Αυτά τα σύμβολα στα προϊόντα, τις συσκευασίες ή/και τα συνοδευτικά έγγραφα σημαίνουν ότι τα ηλεκτρικά και ηλεκτρονικά προϊόντα και οι μπαταρίες δεν πρέπει να αναμιγνύονται με γενικά οικιακά απόβλητα. Για το σωστό χειρισμό, ανάκτηση και ανακύκλωση παλιών προϊόντων και χρησιμοποιημένων μπαταριών, προσκομίστε τα στα κατάλληλα σημεία συλλογής, σύμφωνα με την εθνική νομοθεσία και τις Οδηγίες 2002/96/EK και 2006/66/EK.

Με τη σωστή διάθεση αυτών των προϊόντων και μπαταριών, θα βοηθήσετε στην εξοικονόμηση πολύτιμων πόρων και στην αποφυγή τυχόν δυνητικών αρνητικών επιπτώσεων για την ανθρώπινη υγεία και το περιβάλλον που θα προέκυπταν από τον ακατάλληλο χειρισμό των αποβλήτων.

Για περισσότερες πληροφορίες σχετικά με τη συλλογή και την ανακύκλωση παλιών προϊόντων και μπαταριών, επικοινωνήστε με το δήμο σας, την υπηρεσία διάθεσης αποβλήτων ή το κατάστημα από όπου αγοράσατε τα είδη. Ενδεχομένως να υπάρχουν κυρώσεις για τη λανθασμένη διάθεση αυτών των αποβλήτων, σύμφωνα με την εθνική νομοθεσία.

### Για επιχειρηματικούς χρήστες στην Ευρωπαϊκή Ένωση

Εάν θέλετε να απορρίψετε ηλεκτρικό ή ηλεκτρονικό εξοπλισμό, επικοινωνήστε με τον αντιπρόσωπο ή προμηθευτή σας για περαιτέρω πληροφορίες.

### [Πληροφορίες για τη διάθεση σε άλλες χώρες εκτός της Ευρωπαϊκής Ένωσης]

Τα σύμβολα αυτά ισχύουν μόνο στην Ευρωπαϊκή Ένωση. Εάν θέλετε να απορρίψετε αυτά τα είδη, επικοινωνήστε με τις τοπικές αρχές ή τον αντιπρόσωπό σας και ρωτήστε σχετικά με τη σωστή μέθοδο διάθεσης.



### Ανακοίνωση για το σύμβολο μπαταρίας (παρακάτω δύο παραδείγματα συμβόλου):

Αυτό το σύμβολο μπορεί να χρησιμοποιείται σε συνδυασμό με ένα χημικό σύμβολο. Σε αυτή την περίπτωση συμμορφώνεται με την απαίτηση που καθορίστηκε από την Οδηγία για το εμπλεκόμενο χημικό.



# Ονόματα μερών

## ΕΞΩΤΕΡΙΚΉ ΜΟΝΑΔΑ

### Απλου Συστηματος

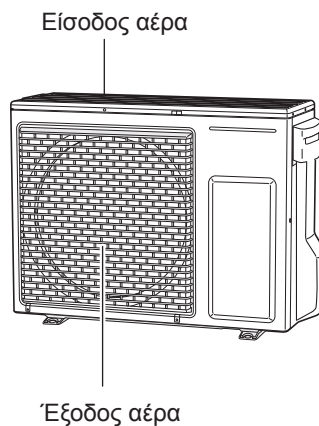

## Προαιρετικό

### Ασύρματο τηλεχειριστήριο

Αρ. μοντέλου  
CZ-RWS3



(Τηλεχειριστήριο  
υπερύθρων)

Αρ. μοντέλου  
CZ-RWSK2



### Τηλεχειριστήριο χρονοδιακόπτη

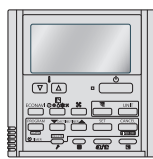

Αρ. μοντέλου  
CZ-RTC4

Για όλες τις  
εσωτερικές  
μονάδες

### Ενσύρματο τηλεχειριστήριο υψηλών προδιαγραφών



Αρ. μοντέλου  
CZ-RTC5B

Για όλες τις  
εσωτερικές  
μονάδες

Διαβάστε τις οδηγίες χρήσης που συνοδεύουν το τηλεχειριστήριο.

### ■ Λειτουργία

Ανατρέξτε στις οδηγίες λειτουργίας που συνοδεύουν το προαιρετικό τηλεχειριστήριο.

### ■ Ρύθμιση κατεύθυνσης ροής αέρα

Ανατρέξτε στις οδηγίες λειτουργίας που συνοδεύουν την εσωτερική μονάδα και το προαιρετικό τηλεχειριστήριο.

### ■ Συντήρηση

Ανατρέξτε στις οδηγίες λειτουργίας που συνοδεύουν την εσωτερική μονάδα.







### ■ Αντιμετώπιση προβλημάτων

Ανατρέξτε στις οδηγίες λειτουργίας που συνοδεύουν την εσωτερική μονάδα.



## Σημαδία για την Οδηγία 2014/68/EU (Οδηγία Εξοπλισμού Πίεσης)

Εικόνα χαρακτηριστικών πινακίδας ονομασίας

<b>Panasonic</b>			<b>CE</b> 0035
Air Conditioner		<b>Model No.</b> A: Model Name Various	
POWER SOURCE : B: Various			
MAX ELECTRIC INPUT C: kW A			
TIME DELAY FUSE MAX SIZE : D: A			
UNIT PROTECTION : IPX4			
Operating Spec. Area Various (Not for the PED)			
MAX.WORKING PRESSURE : HIGH SIDE E: bar ( MPa) Various LOW SIDE F: bar ( MPa) Various			
REFRIGERANT : R32 G: kg Various			
NET WEIGHT: Various (Not for the PED)			
SERIAL NO. : Various		PROD. DATE : YYYY.MM	
THE CAPACITY, CURRENT AND POWER INPUT ARE FOR THIS UNIT CONNECTED TO THE FOLLOWING INDOOR UNITS. Various (Not for the PED) FOR OTHER COMBINATIONS, REFER TO MANUAL.			
Authorized representative in EU Panasonic Testing Centre		Panasonic Marketing Europe GmbH Winsbergring 15, 22525 Hamburg, Germany	
Panasonic Corporation 1006 Kadoma, Kadoma City, Osaka, Japan			Made in Malaysia
    			
 THIS PRODUCT CONTAINS FLUORINATED GREENHOUSE GASES R 3 2 GWP=6 7 5 Various			

### Πίνακας διαφόρων στοιχείων



A	U-36PZH2E5	U-50PZH2E5	U-60PZH2E5
B	220 - 230 - 240 V~ 50 Hz		
C	2,40 kW, 11,0 A	2,68 kW, 12,0 A	3,54 kW, 16,4 A
D	20 A	20 A	25 A
E	41,5 bar (4,15 MPa)		
F	27,0 bar (2,70 MPa)		
G	1,15 kg	1,15 kg	1,45 kg

A	U-60PZ2E5	U-71PZ2E5
B	220 - 230 - 240 V~ 50 Hz	
C	3,54 kW, 16,4 A	3,54 kW, 16,4 A
D	25 A	25 A
E	41,5 bar (4,15 MPa)	
F	25,5 bar (2,55 MPa)	
G	1,45 kg	1,45 kg

Благодарим ви за закупуването на този продукт на Panasonic.  
Този продукт представлява вътрешно тяло на климатик.  
Инструкциите за монтаж са прикрепени.

# Съдържание

● Мерки за безопасност.....	50
● Предпазни мерки при употреба.....	53
● Наименования на компонентите.....	54
● Спецификации.....	62
• Външно тяло.....	62
• Таблица на съответния език.....	62

	<b>ПРЕДУПРЕЖДЕНИЕ</b>	Този символ показва, че уредът използва запалим хладилен агент. Ако има изтичане на хладилен агент, заедно с външен източник на запалване, има вероятност от запалване.
	<b>ВНИМАНИЕ</b>	Този символ показва, че това оборудване трябва да се обслужва от сервизен персонал като се прави справка с Техническото ръководство.
	<b>ВНИМАНИЕ</b>	Този символ показва, че има информация, включена в Инструкциите за експлоатация и/или монтаж.

## Информация за продукта

Ако имате проблеми или въпроси, свързани с климатика, следната информация ще ви бъде полезна. Моделът и серийният номер са на фирмената табелка.

Модел №	_____
Сериен №	_____
Дата на закупуване	_____
Адрес на търговеца	_____
Телефонен номер	_____

### Важна информация, касаеща използвания хладилен агент

Този продукт съдържа флуорирани парникови газове. Не изпускайте газове в атмосферата.

Вид на хладилния агент: R32



GWP<sup>(1)</sup> стойност: 675

<sup>(1)</sup>GWP = global warming potential (глобален потенциал на затопляне)

Възможно е да се изисква периодична проверка за изтичане на хладилен агент съгласно европейското и местно законодателство. За повече информация се обърнете към Вашия дилър.

# Мерки за безопасност

Следните символи в настоящата инструкция за експлоатация се използват, за да ви предупредят за потенциално опасни условия за потребителите, сервизния персонал или уреда:

	<b>ПРЕДУПРЕЖДЕНИЕ</b>	Този символ обозначава опасност или опасно действие, които могат да доведат до тежки телесни повреди или смърт.
	<b>ВНИМАНИЕ</b>	Този символ обозначава опасност или опасно действие, които могат да доведат до телесни повреди, вреди върху продукта или друго имущество.

	<b>Забранени действия</b>		<b>Съвети, които трябва да се спазват</b>
---	---------------------------	---	---

- Прочетете внимателно тези Инструкции за експлоатация преди да използвате климатика. Ако все още изпитвате затруднения или проблеми, обърнете се за помощ към търговеца.
- Този климатик е предназначен да осигурява приятна атмосфера в помещения. Използвайте го единствено по предназначение, както е описано в настоящите инструкции за експлоатация.

## ПРЕДУПРЕЖДЕНИЕ



Искайте потвърждение от оторизиран дилър или специалист дали може да се използва различен тип хладилен агент. Използването на хладилен агент, различен от определения тип, може до предизвика повреда на продукта, експлозия, нараняване и други нежелани последствия.

Този климатик няма вентилатор, който да вкарва чист въздух отвън. Трябва често да отваряте вратите или прозорците, когато в същото помещение използвате отоплителни уреди с газ, нафта или подобни, които при работа изгарят значително количество от кислорода във въздуха в стаята. В противен случай съществува дори опасност от задушаване.



Никога не използвайте или складирайте бензин или други вещества с лесно запалими пари в близост до климатика – това е изключително опасно.

Не използвайте този уред във взривоопасна среда.

Никога не докосвайте уреда с мокри ръце.

Не пъхайте пръстите си или други предмети във вътрешната или външната част на климатика, тъй като въртящите се части може да причинят нараняване.



## ПРЕДУПРЕЖДЕНИЕ



Ако хладилният агент влезе в контакт с открит пламък е възможно да се отдели токсичен газ.

От съображения за безопасност винаги изключвайте климатика и захранването му преди почистване и обслужване.

При авария изключете климатика от електрическото захранване, като издърпате щепсела от контакта, изключите прекъсвача или изключите захранването.



Да се изхвърли според националните и/или местни разпоредби.



Този продукт не трябва да бъде променян или разглобяван при никакви обстоятелства. Променен или разглобен модул може да предизвика пожар, токов удар или нараняване.

Почистването на вътрешността на вътрешното и външното тяло не трябва да се извършва от потребителите. Ангажирайте оторизиран дилър или специалист за почистването.

Не се опитвайте сами да поправите уреда в случай на повреда. Свържете се с дилър по продажбите или сервизен център за ремонт и изхвърляне.



Осигурете розетка, която да бъде ползвана изключително само за всеки модул, а прекъсвач за електрозахранването, прекъсвач при утечка на заземяването (ELCB) или устройство за остатъчен ток за защита при претоварване трябва да бъдат осигурени в една линия.

Осигурете отделен ел. контакт за всеки уред, както и пълна двустранна защита, която прекъсва захранването във всички полюси и е интегрирана в окабеляването в съответствие със стандартите за окабеляване.

За да се предотвратят опасности, които могат да възникнат в резултат на нарушена изолация, уредът трябва да бъде заземен.



Не използвайте модифициран кабел, общ кабел, удължител или неотговарящ на изискванията кабел, за да предотвратите прегряване и пожар.



Уредът трябва да се съхранява в стая без постоянно работещи източници на огън (например: открити огнища, работещ газос уред или електрически нагревател).

Трябва да знаете, че хладилните агенти може да нямат мирис.

Невентилирана зона, в която се инсталира уреда със запалими хладилни агенти трябва така да се проектира, че, ако има изтичане на хладилен агент, да не се задържа, за да не се създаде риск от пожар или експлозия.

Уредът трябва да се съхранява в добре вентилирана зона, в която големината на стаята отговаря на посочената за дейността нейна площ.

След монтиране на модула, никога не пропускайте да попитате монтажника пространството на пода в стаята, в която се монтира модула, както и какво количество охладителен агент трябва да се зареди.

В случай, че се промени разделителя за модула или стаята, никога не пропускайте да се консултирате с търговеца по продажбите или със сервизния техник.





Да не се използват други средства за ускоряване процеса на размразяване или за чистене освен споменатите от производителя.

Да не се пробива или гори.

В случаите, когато се изисква механична вентилация, отворите за вентилация трябва да се почистват от препятствия.

## ПРЕДУПРЕЖДЕНИЕ



 Уредът трябва да се съхранява в стая без постоянно работещи източници на открит огън (например: работещ газов уред) и източници на огън (например: работещ електрически нагревател).

 Спрете да използвате продукта, когато възникне аномалия/повреда и извадете щепсела от контакта или изключете от копчето и автоматичния превключвател. (Опасност от задимяване/пожар/токов удар)

Примери за необичайна работа или повреда:

- Заземителният автоматичен прекъсвач (ELCB) често се активира.
- Климатикът не стартира когато е включен.
- Захранването прекъсва, когато кабелът се мести.
- Мирише на изгоряло или издава необичаен шум при работа.
- Корпусът е деформиран или необичайно горещ.
- Изтича вода от вътрешния уред.
- Кабелът или щепселът са необичайно горещи.
- Скоростта на вентилатора не може да се контролира.
- Уредът спира работа веднага, дори и да е включен да работи.
- Вентилаторът не спира, дори, ако уредът е спрял да работи.

За техническо обслужване или ремонт се свържете незабавно с местния търговец.

 Не сядайте и не стъпвайте върху уреда. Има опасност да паднете. 

## ВНИМАНИЕ

 Този уред е предназначен за използване от експерти или обучени потребители в търговски обекти, в леката промишленост, във ферми или за търговски цели от неспециалисти.

Този уред може да се използва от деца на възраст 8 и повече години и от хора с ограничени физически, сетивни или умствени способности или липса на опит и познания, ако се наблюдават или са инструктирани относно използването на уреда по безопасен начин, и осъзнават опасностите, които това включва. Децата не трябва да си играят с уреда. Почистването и поддържането от потребителите не трябва да се прави от деца без надзор.



Дръжте противопожарната аларма и изходният отвор за въздух на най-малко 1,5 м от уреда.

Не охлаждайте и не затопляйте прекалено много помещението, ако в него се намират бебета или инвалиди.

 Не включвайте и не изключвайте климатика от ключа за централното захранване. Използвайте бутона за пускане и спиране ВКЛ./ИЗКЛ. (ON/OFF).

Не мушкате нищо в изходния отвор за въздух на външното тяло. Това е опасно, тъй като вентилаторът се върти с висока скорост. 

Не докосвайте входния отвор за въздух или острият алуминиеви ребра на външното тяло. Може да се нараните. 

Не мушкайте предмети в корпуса на вентилатора. Така можете да се нараните или да повредите уреда.  

### ЗАБЕЛЕЖКА

- Уредът трябва да се съхранява така, че да се предотврати механична повреда.
- Компресорът понякога спира по време на гръмотевични бури. Това не е механична повреда. Уредът автоматично възстановява работата си след няколко минути.
- Оригиналният текст на тези инструкции е на английски език. Текстовете на останалите езици са превод на оригиналните инструкции.

# Предпазни мерки при употреба

## Монтаж

- Този климатик трябва да се инсталира правилно от квалифицирани монтажни техници в съответствие с инструкциите за монтаж, предоставени с уреда.
- Преди монтаж проверете дали напрежението на електрическото захранване в дома или офиса ви съответства на указания волтаж на фабричната табелка.

## ПРЕДУПРЕЖДЕНИЕ

### Избягвайте следните места за монтаж.

- Места, където съществува дим или горим газ. Места с изключително висока температура, като оранжерия.
- Места, където се поставят прекалено високи предмети, генериращи топлина.

### Внимание:

- Избягвайте инсталирането на външното тяло на места, където солена морска вода може директно да пръска върху него или при наличие на сернист въздух в близост до минерални извори. (За да се предпази климатикът от тежка корозия)

## Окабеляване

- Окабеляването трябва да е в съответствие с местните стандарти за електрически инсталации. (За подробна информация се консултирайте се с търговеца или с квалифициран електротехник.)
- Всеки модул трябва да бъде надлежно заземен посредством заземителен проводник или чрез заземяването на захранващия кабел.
- Свързването към електрическата инсталация трябва да се извърши от квалифициран електротехник.

## Подготовка за работа

### Включете захранването 5 часа преди началото на работа. (За захранване)

- Оставете захранването включено за продължителна употреба.



### БЕЛЕЖКА

Когато няма да използвате климатика за дълъг период от време, изключете го от електрическото захранване, като издърпате щепсела от контакта, изключите прекъсвача или изключите захранването.

### Информация за потребителите за събиране и обезвреждане на старо оборудване и използвани батерии



Тези символи на продукти, опаковки и/или придружаващи документи означават, че използваните електрически и електронни продукти и батерии не трябва да се смесват с обикновените битови отпадъци.

За правилно третиране, оползотворяване и рециклиране на стари продукти и употребявани батерии, моля да ги предадете в съответните събирателни пунктове, в съответствие с националното законодателство и директиви 2002/96/ЕО и 2006/66/ЕО.

Чрез правилно изхвърляне на тези продукти и батерии, ще помогнете за спасяването на ценни ресурси и за предотвратяване на потенциални отрицателни ефекти върху човешкото здраве и околната среда, които биха могли да възникнат при неправилно изхвърляне.

За повече информация за събирането и рециклирането на стари продукти и батерии, моля, свържете се с местната община, службата за изхвърляне на отпадъци или мястото, от където сте закупили продуктите. Може да бъдете глобени за неправилно изхвърляне на тези отпадъци, в съответствие с националното законодателство.

### За бизнес потребители в Европейския съюз

Ако искате да изхвърлите електрическо и електронно оборудване, моля, свържете се с вашия търговец или доставчик за повече информация.

### [Информация за изхвърляне в други страни извън Европейския съюз]

Тези символи са валидни само в Европейския съюз. Ако искате да изхвърлите тези продукти, моля, свържете се с местните власти или търговеца и попитайте за правилния начин на изхвърляне.



### Бележка за символа на батерията (долните два примерни символа):

Този символ може да се използва в комбинация с химически символ. В този случай е в съответствие с изискванията, определени от директивата за съответния химикал.



# Наименования на компонентите

## ВЪНШНО ТЯЛО

### Единичен Сплит

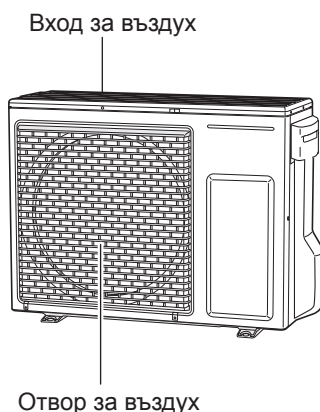

## Опция

### Безжично дистанционно управление

Модел №  
CZ-RWS3



(Безжично дистанционно управление)

Модел №  
CZ-RWSK2



### Дистанционно управление с таймер

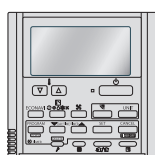

Модел №  
CZ-RTC4

За всички  
вътрешни тела

### Високоспециализирано кабелно дистанционно управление



Модел №  
CZ-RTC5B

За всички  
вътрешни тела

Прочетете инструкциите за експлоатация, приложени към дистанционното управление.

### ■ Действие

Обърнете се към инструкцията за експлоатация, доставена с допълнително доставяното дистанционно управление.

### ■ Регулиране на посоката на въздушния поток

Обърнете се към Инструкцията за експлоатация, доставена с вътрешния модул и допълнително доставяното дистанционно управление.

### ■ Поддръжка

Обърнете се към инструкцията за експлоатация, доставена с вътрешния модул.

### ■ Отстраняване на проблеми

Обърнете се към инструкцията за експлоатация, доставена с вътрешния модул.

**Маркировка съгласно Директива 2014/68/EU (Директива за Оборудване под Налягане)**

Фигура на фабрична табела с номинални данни



<b>Panasonic</b>			<b>CE</b> 0035
Air Conditioner		<b>Model No.</b> A: Model Name Various	
POWER SOURCE : B: Various			
MAX ELECTRIC INPUT : C: kW A			
TIME DELAY FUSE MAX SIZE : D: A			
UNIT PROTECTION : IPX4			
Operating Spec. Area Various (Not for the PED)			
MAX.WORKING PRESSURE : HIGH SIDE E: bar (MPa) Various LOW SIDE F: bar (MPa) Various			
REFRIGERANT : R32 G: kg Various			
NET WEIGHT: Various (Not for the PED)			
SERIAL NO. : Various		PROD. DATE : YYYY.MM	
THE CAPACITY, CURRENT AND POWER INPUT ARE FOR THIS UNIT CONNECTED TO THE FOLLOWING INDOOR UNITS. Various (Not for the PED) FOR OTHER COMBINATIONS, REFER TO MANUAL.			
Authorized representative in EU Panasonic Testing Centre		Panasonic Marketing Europe GmbH Winsbergring 15, 22525 Hamburg, Germany	
Panasonic Corporation 1006 Kadoma, Kadoma City, Osaka, Japan			Made in Malaysia
<b>R32</b>    			
 THIS PRODUCT CONTAINS FLUORINATED GREENHOUSE GASES R 3 2 GWP=6 7 5			
Various			

Таблица с различни данни

A	U-36PZH2E5	U-50PZH2E5	U-60PZH2E5
B	220 - 230 - 240 V~ 50 Hz		
C	2,40 kW, 11,0 A	2,68 kW, 12,0 A	3,54 kW, 16,4 A
D	20 A	20 A	25 A
E	41,5 бара (4,15 MPa)		
F	27,0 бара (2,70 MPa)		
G	1,15 кг	1,15 кг	1,45 кг



A	U-60PZ2E5	U-71PZ2E5
B	220 - 230 - 240 V~ 50 Hz	
C	3,54 kW, 16,4 A	3,54 kW, 16,4 A
D	25 A	25 A
E	41,5 бара (4,15 MPa)	
F	25,5 бара (2,55 MPa)	
G	1,45 кг	1,45 кг

БЪЛГАРСКИ

Bu Panasonic ürününü satın aldığınız için teşekkür ederiz.  
Bu ürün ticari bir klima iç ünitesidir.  
Montaj Talimatları ektedir.

# İçindekiler

● Güvenlik Önlemleri .....	56
● Kullanım Uyarıları .....	59
● Parçaların Adları.....	60
● Teknik Özellikler .....	62
• Dış ünite.....	62
• İlgili dil tablosu.....	62

	<b>UYARI</b>	Bu simge cihazda tutuşabilir bir soğutucu akışkan kullanıldığını göstermektedir. Soğutucu akışkan kaçağı meydana gelirse harici bir ateşleme kaynağıyla tutuşma riski söz konusudur.
	<b>İKAZ</b>	Bu simge, servis personelinin bu cihazı Teknik Kılavuza uygun şekilde taşıması gerektiğini gösterir.
	<b>İKAZ</b>	Bu simge, gerekli bilgilerin Kullanım Talimatlarında ve/veya Montaj Talimatlarında verildiğini gösterir.

## Ürün Bilgisi

Klimanızla ilgili bir sorun veya sorunuz varsa, aşağıdaki bilgilere gerek duyacaksınız. Model ve seri numaraları değer etiketinde yazılıdır.

Model numarası

Seri numarası

Satın alma tarihi

Satıcının adresi

Telefon numarası

## Kullanılan Soğutucu Akışkan İle İlgili Önemli Bilgi

Bu ürün florlanmış sera gazları içerir. Gazı atmosfere salmayın.

Soğutucu Akışkan: R32



GWP<sup>(1)</sup> değeri: 675

<sup>(1)</sup>GWP = global warming potential (Küresel Isınma Potansiyeli)

Avrupa Birliği veya yerel yasal düzenlemelere bağlı olarak gaz kaçaklarını düzenli olarak denetlenmesi gerekebilir. Lütfen daha fazla bilgi için yetkili satıcınızla iletişime geçiniz.

# Güvenlik Önlemleri

Bu kılavuzda kullanılan aşağıdaki simgeler kullanıcılar, servis personeli veya cihaz açısından riskli olabilecek durumlara karşı sizi uyarmak içindir:

	<b>UYARI</b>	Bu simge ciddi kişisel yaralanma veya ölümlü sonuçlanabilecek bir risk veya emniyetsiz işlemi belirtir.
	<b>İKAZ</b>	Bu simge kişisel yaralanma veya maddi hasarla sonuçlanabilecek bir risk veya emniyetsiz işlemi belirtir.

	Yasak hususlar		Dikkate alınması gereken hususlar
---	----------------	---	-----------------------------------

- Bu klimayı kullanmaya başlamadan önce bu Çalıştırma Talimatlarını dikkatle okuyun. Hala zorlanıyorsanız veya sorun yaşıyorsanız, yardım almak için satıcınıza başvurun.
- Bu klima size konforlu oda koşulları sağlamak için tasarlanmıştır. Bu cihazı yalnızca Çalıştırma Talimatlarında belirtilen amaçlar için kullanın.

## UYARI



Yetkili servisin veya teknik uzmanın belirtilen soğutucu akışkan türünü kullandığını onaylayın. Belirtilenden farklı türde bir soğutucu akışkanın kullanılması ürünün hasar görmesine, patlamaya, yaralanmalara vb. yol açabilir.

Bu klimada dışarıdan taze hava girişi için bir vantilatör bulunmamaktadır. Aynı odada gaz ve petrolle çalışan ısıtma cihazlarını kullanıyorsanız, bu cihazlar havadaki oksijeni hızla tükettiği için, kapı veya pencereleri sık sık açmanız gerekir. Aksi takdirde uç bir durumda havasızlıktan zehirlenme riski ortaya çıkar.



Hiçbir zaman klimanın yakınında gaz veya uçucu buhar veya sıvı bulundurmeyin — bu çok tehlikelidir.

Bu cihazı patlama olasılığı bulunan bir ortamda kullanmayın.

Asla üniteye ıslak elle dokunmayın.

Parmaklarınızı veya başka nesnelere klimanın iç veya dış ünitesinin içine sokmayın, aksi takdirde dönen parçalar yaralanmanıza sebep olabilir.





## ! UYARI



Soğutucu akışkan ateşle temas ederse zehirli bir gaz açığa çıkar.

Emniyetiniz için temizlik veya bakım işlemlerinden önce klimayı kapalı konuma getirdiğinizden ve elektriği kestiğinizden emin olun.

Acil bir durumda klimanın elektriğini kesmek için fişi prizden çekin veya sigortayı kapatın veya güç kesme cihazını kapalı konuma getirin.



Ulusal ve/veya yerel mevzuatlara uygun olarak bertaraf edin.



Hiçbir durumda ünite üzerinde değişiklik yapılmamalı ve ünite sökülmemelidir. Üzerinde değişiklik yapılan veya sökülen bir ünite yangın, elektrik şoku veya yaralanmalara yol açabilir.

İç ve dış üniteler kullanıcılar tarafından temizlememelidir. Temizlik işlemi için yetkili satıcı veya teknik uzmana başvurun.

Bu cihazın arızalanması durumunda kendiniz onarmaya çalışmayın. Onarım ve elden çıkarma için yetkili satıcı veya teknik uzmana başvurun.



Her ünite için yalnızca o üniteyi besleyen bir priz kullanılmalı ve aşırı akım koruması için özel bir hatta güç besleme kesici, Toprak Kaçağı Devre Kesicisi (ELCB) veya Artık Akım Cihazı (RCD) sağlanmalıdır.

Her üniteyle yalnızca o üniteyi besleyen bir priz kullanın. Sabitlenen kablolarda mutlaka ilgili kablolama kurallarına uygun olarak, tüm kutuplarda kontak ayırma özelliğine sahip bağlantı kesme araçları kullanılmalıdır.

Yalıtım kaçaklarından kaynaklanabilecek tehlikelerin önlenmesi için ünite mutlaka topraklanmalıdır.



Aşırı ısınmaya ve yangına neden olmamak için, üzerinde değişiklik yapılmış kabloları, bağlantı kablolarını, uzatma kablolarını veya ilgili değerleri karşılamayan kabloları kesinlikle kullanmayın.



Cihaz kesinlikle sürekli aktif ateşleme kaynaklarının (ör. açık alev, gazla çalışan bir cihaz veya elektrikli ısıtıcı) bulunduğu bir odada saklanmamalıdır.

Soğutucu akışkanların koku içermeyebileceğine dikkat edin.

Tutuşabilir soğutucu akışkanların kullanıldığı cihazın monte edildiği alan havalandırılmıyorsa yangın veya patlama tehlikelerinin ortadan kaldırılması için bu alan, soğutucu akışkan kaçağı durumunda gazların birikmesini önleyecek bir yapıda olmalıdır.

Cihaz, çalıştırma için belirtilen oda yüzölçümüne uygun büyüklükteki bir odada, iyi havalandırılan bir alanda saklanmalıdır.

Ünite monte edildikten sonra montörden ünitenin monte edildiği odanın yüz ölçümünü ve soğutucu akışkan şarj miktarını öğrenmeyi lütfen unutmayın.

Ünite veya oda ayırıcı değiştirilirse satış danışmanınıza veya servis merkezine danışmayı lütfen unutmayın.



Defrost sürecini hızlandırmak veya temizlik yapmak için üretici tarafından belirtilenler dışında başka yöntem kullanmayın.

Delmeyin ve yakmayın.

Mekanik havalandırma gerektiren durumlarda havalandırma açıklıklarının engellenmemesine dikkat edilmelidir.

## ⚠ UYARI



Cihaz kesinlikle sürekli aktif açık alevin (ör. çalışan gazlı cihaz) ve ateşleme kaynaklarının (ör. çalışan elektrikli ısıtıcı) bulunduğu bir odada saklanmamalıdır.



Herhangi bir anormallik/arıza olursa ürünü kullanmayı bırakın ve elektrik bağlantısını kesin veya devre kesicisini kapatın. (Duman/yangın/elektrik çarpması riski)

Anormallik/arıza örnekleri:

- ELCB sık sık devreye giriyor.
- Ürün açık konuma getirildiğinde bazen çalışmaya başlamıyor.
- Kablo hareket edince bazen elektrik kesiliyor.
- Çalışma esnasında yanık konusu veya anormal ses duyuluyor.
- Gövde deforme olmuş veya anormal derecede sıcak.
- İç üniteden su damlıyor.
- Elektrik kablosu veya fişi anormal derecede ısınıyor.
- Fan devri kontrol edilemiyor.
- Ünite çalıştırmak üzere açılrsa bile hemen kapanıyor.
- Çalışma durduğu halde fan durmuyor.

Bakım/onarım için satıcınıza başvurun.



Ünitenin üstüne oturmeyin veya basmayın. Kazayla düşebilirsiniz.



## ⚠ İKAZ



Bu cihaz mağazalarda, aydınlatma endüstrisinde, çiftliklerde veya başka ticari kullanım alanlarında uzman veya eğitilmiş kişiler tarafından kullanım için tasarlanmıştır.

Bu cihaz 8 yaşında ve daha büyük çocuklar tarafından, fiziksel, duyuşal veya zihinsel yetenekleri kısıtlı veya deneyimsiz ve bilgi sahibi olmayan kişiler tarafından, cihazın emniyetli bir biçimde kullanımı için gerekli talimatların verilmiş olması ve riskleri anlamaları şartıyla kullanılabilir. Çocuklar bu cihazla oynamamalıdır. Temizlik ve kullanıcı bakım işlemlerini çocuklar tek başlarına yapmamalıdır.

Yangın alarmı ve hava çıkışı ünitenin en az 1,5 m uzağında olmalıdır.

Odada bebekler ve yatağa bağımlı hastalar varsa odayı çok fazla ısıtmayın ve soğutmayın.



Klimayı güç düğmesinden kapatıp açmayın. AÇMA/KAPAMA düğmesini kullanın.

Dış ünitenin hava çıkışına kesinlikle hiçbir şey yapıştırmayın. İçindeki fan yüksek hızda döndüğünden tehlikeli sonuçlar doğurabilir.



Dış ünitenin hava girişine ve keskin alüminyum kanatlarına dokunmayın. Yaralanabilirsiniz.



FAN GÖVDESİNE kesinlikle hiçbir şey yapıştırmayın.



Yaralanabilirsiniz ve ünite hasar görebilir.

## BİLDİRİM

- Cihaz, olası mekanik hasarları önleyecek şekilde saklanmalıdır.
- Kompresör şimşek çakarken bazen durabilir. Bu mekanik bir arıza değildir. Ünite birkaç dakika sonra otomatik olarak normal çalışmaya başlar.
- İngilizce metin orijinal talimatlardır. Diğer diller, orijinal talimatların çevirileridir.

# Kullanım Uyarıları

## Montaj

- Bu klima yetkili montaj teknisyenleri tarafından üniteyle beraber verilen Montaj Talimatlarına uygun bir biçimde düzgün olarak monte edilmelidir.
- Montajdan önce, evinizdeki ya da iş yerinizdeki elektrik beslemesinin geriliminin değer etiketinde belirtilen değerle aynı olduğunu kontrol edin.

## UYARI

### Montaj için aşağıdaki yerlerden kaçının.

- Duman veya tutuşabilir gazların bulunduğu ortamlar. Ayrıca, seralar vb. gibi aşırı yüksek sıcaklıkların olduğu yerler.
- Çok yüksek sıcaklıklar üreten nesnelerin bulunduğu yerler.

### Dikkat:

- Dış üniteyi için tuzlu deniz suyunun sıçrayabileceği veya bir spa gibi sülfürlü havanın bulunduğu yerlere monte etmeyin. (Klimayı ağır korozyona karşı korumak için)

## Kablolama

- Tüm kablolar mutlaka ilgili elektrik standartlarına uygun olmalıdır. (Ayrıntılı bilgi için satıcınıza veya yetkili bir elektrik teknisyenine danışın.)
- Her ünite bir toprak kablosuyla veya besleme kabloları üzerinden topraklanmalıdır.
- Kablolama yetkili bir elektrik teknisyeni tarafından yapılmalıdır.

## Çalıştırma Hazırlığı

### Ana şebekeyi, çalışmayı başlatmadan 5 saat önce açık konuma getirin.

(Isınma için)

- Sürekli kullanım için ana şebekeyi AÇIK konumda bırakın.

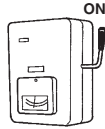

### NOT

Klimayı uzun süre kullanmayacağınız zaman elektrik fişini prizden çekin veya sigortayı kapatın veya güç kesme cihazını kapalı konuma getirin.

### Kullanıcıların Eski Cihazları ve Kullanılmış Pilleri Toplaması ve Bertaraf Etmesiyle İlgili Bilgiler



Ürün, ambalaj ve/veya ürünle verilen belgeler üzerindeki bu simgeler, kullanılan elektrikli ve elektronik ürünlerin ve pillerinin ve akülerinin genel evsel atıklarla karıştırılmaması gerektiğini gösterir.

Eskimiş ürünlerin ve bitmiş pillerin düzgün bir biçimde işlenmesi, kurtarılması ve geri dönüşümü için bunları lütfen ilgili kanunlar ve 2002/96/EC ve 2006/66/EC sayılı Direktifler uyarınca uygun toplama merkezlerine götürün. Bu ürünleri ve pilleri doğru biçimde bertaraf ederek, değerli kaynakları korumaya yardımcı olursunuz ve uygunsuz şekilde bertaraf edilmesi durumunda insan sağlığı ve çevre üzerinde ortaya çıkabilecek potansiyel olumsuz etkileri önlersiniz.

Eski ürün ve pillerin toplanması ve geri dönüşümü hakkında daha fazla bilgi için lütfen yerel belediyenizle, çöp toplama hizmetini veren kuruluşla veya ürünleri satın aldığınız mağazayla irtibata geçin.

Bu çöplerin yanlış bertaraf edilmesi durumunda ulusal yasalar uyarınca cezalar söz konusu olabilir.

**Avrupa Birliği'ndeki ticari kullanıcıları için** Elektrikli veya elektronik cihazları çöpe atmak istiyorsanız bilgi edinmek için lütfen satıcınıza veya tedarikçinize danışın.

### [Avrupa Birliği dışındaki Ülkelerde Bertaraf İlgili Bilgiler]

Bu simgeler yalnızca Avrupa Birliğinde geçerlidir. Bu ürünleri çöpe atmak isterseniz, doğru bertaraf yöntemi için lütfen yetkili kurumlarla irtibat kurun ve doğru yöntemin ne olduğunu öğrenin.



### Pil simgesi için not (en alttaki iki simge örneği):

Bu simge bir kimyasal madde simgesiyle birlikte kullanılabilir. Bu durumda, ilgili kimyasal maddeler için geçerli Direktifin gereksinimlerine uygundur.



# Parçaların Adları

## DIŞ ÜNİTE

### Tekli Split

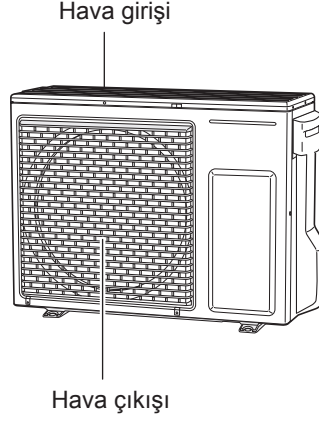

## Opsiyonel

### Uzaktan Kumanda

Model numarası  
CZ-RWS3



(Kablosuz Uzaktan  
Kumanda)

Model numarası  
CZ-RWSK2



### Zamanlayıcı Uzaktan Kumanda

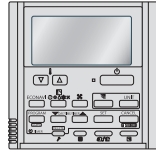

Model numarası  
CZ-RTC4

Tüm iç üniteler  
için

### Yüksek Özellikli Kablolu Kumanda



Model numarası  
CZ-RTC5B

Tüm iç üniteler  
için

Uzaktan Kumanda ile birlikte verilen Çalıştırma Talimatlarını okuyun.

#### ■ Çalıştırma

Opsiyonel Uzaktan Kumanda ile birlikte verilen Çalıştırma Talimatlarına bakın.

#### ■ Hava Akımı Yönünü Ayarlama

İç ünite ve opsiyonel Uzaktan Kumanda ile verilen Çalıştırma Talimatlarına bakın.

#### ■ Bakım



İç mekan ünitesi ile birlikte verilen Çalıştırma Talimatlarına bakın.

#### ■ Sorun Giderme

İç mekan ünitesi ile birlikte verilen Çalıştırma Talimatlarına bakın.

## 2014/68/EU (PED) Direktifi uyarınca İşaretler

Değer etiketi şekli

<b>Panasonic</b>			0035	
Air Conditioner	Model No.	A: Model Name Various		
POWER SOURCE :	B: Various			
MAX ELECTRIC INPUT :	C: kW	A		
TIME DELAY FUSE MAX SIZE :	D: A	-		
UNIT PROTECTION :	IPX4			
Operating Spec. Area Various (Not for the PED)				
MAX.WORKING PRESSURE :	HIGH SIDE:	E: bar ( MPa)	Various	
	LOW SIDE:	F: bar ( MPa)	Various	
REFRIGERANT :	R32	G: kg	Various	
NET WEIGHT :	Various (Not for the PED)			
SERIAL NO. :	Various	PROD. DATE :	YYYY.MM	
THE CAPACITY, CURRENT AND POWER INPUT ARE FOR THIS UNIT CONNECTED TO THE FOLLOWING INDOOR UNITS. Various (Not for the PED) FOR OTHER COMBINATIONS, REFER TO MANUAL.				
Authorized representative in EU Panasonic Testing Centre		Panasonic Marketing Europe GmbH Winsbergring 15, 22525 Hamburg, Germany		
Panasonic Corporation 1006 Kadoma, Kadoma City, Osaka, Japan			Made in Malaysia	
<b>R32</b>				
	THIS PRODUCT CONTAINS FLUORINATED GREENHOUSE GASES R 3 2 GWP=6 7 5			Various

### Muhtelif veriler içeren tablo

A	U-36PZH2E5	U-50PZH2E5	U-60PZH2E5
B	220 - 230 - 240 V~ 50 Hz		
C	2,40 kW, 11,0 A	2,68 kW, 12,0 A	3,54 kW, 16,4 A
D	20 A	20 A	25 A
E	41,5 bar (4,15 MPa)		
F	27,0 bar (2,70 MPa)		
G	1,15 kg	1,15 kg	1,45 kg

A	U-60PZ2E5	U-71PZ2E5
B	220 - 230 - 240 V~ 50 Hz	
C	3,54 kW, 16,4 A	3,54 kW, 16,4 A
D	25 A	25 A
E	41,5 bar (4,15 MPa)	
F	25,5 bar (2,55 MPa)	
G	1,45 kg	1,45 kg

TÜRKÇE

# Specifications

## Outdoor unit

### Single Split Outdoor Unit (R32)

Model Name		U-36PZH2E5	U-50PZH2E5	U-60PZH2E5
Power source		220 - 230 - 240 V~ 50 Hz		
Cooling capacity	kW	3.6	5.0	6.0
	BTU/h	12,300	17,100	20,500
Heating capacity	kW	4.0	5.6	7.0
	BTU/h	13,600	19,100	23,900
Sound Pressure level (Cooling / Heating)	dB(A)	43 / 44	45 / 48	46 / 49
Sound Power level (Cooling / Heating)	dB(A)	62 / 64	64 / 68	65 / 69
Unit Dimensions (H×W×D)	mm	695×875×320	695×875×320	695×875×320
Net weight	kg	43	43	44

#### Operation condition temperature range

• Cooling mode : -15°C~46°C DB • Heating mode : -20°C~18°C WB / -20°C~24°C DB

Model Name		U-60PZ2E5	U-71PZ2E5
Power source		220 - 230 - 240 V~ 50 Hz	
Cooling capacity	kW	6.0	7.1
	BTU/h	20,500	24,200
Heating capacity	kW	6.0	7.1
	BTU/h	20,500	24,200
Sound Pressure level (Cooling / Heating)	dB(A)	46 / 48	49 / 49
Sound Power level (Cooling / Heating)	dB(A)	65 / 68	69 / 69
Unit Dimensions (H×W×D)	mm	695×875×320	695×875×320
Net weight	kg	44	44

#### Operation condition temperature range

• Cooling mode : -10°C~43°C DB • Heating mode : -15°C~18°C WB / -15°C~24°C DB

#### Rated conditions

Cooling : Indoor intake air temp. 27°C DB / 19°C WB. Outdoor intake air temp. 35°C DB.

Heating : Indoor intake air temp. 20°C DB. Outdoor intake air temp. 7°C DB / 6°C WB.

## Corresponding language table

English	Français	Español	Deutsch
Single Split	Bi-bloc simple	Un solo split	Einzel-Split

English	Italiano	Nederlands	Português
Single Split	Split singolo	Enkele splitsing	Single split

English	Ελληνική	Български	Türkçe
Single Split	Απλου συστηματος	Единичен сплит	Tekli Split

## Corresponding language table

English	Français	Español	Deutsch
Model Name	Nom du modèle	Nombre del modelo	Modellbezeichnung
Power Source	Source d'alimentation	Fuente de alimentación	Spannungsquelle
Cooling Capacity	Capacité de refroidissement	Capacidad de refrigeración	Kühlleistung
Heating Capacity	Capacité de chauffage	Capacidad de calefacción	Heizleistung
Sound Pressure Level (Cooling / Heating)	Niveau de pression sonore (Refroidissement / Chauffage)	Nivel de presión acústica (Refrigeración / Calefacción)	Schalldruckpegel (Kühlen / Heizen)
Sound Power Level (Cooling / Heating)	Niveau de puissance sonore (Refroidissement / Chauffage)	Nivel de potencia acústica (Refrigeración / Calefacción)	Schalleistungspegel (Kühlen / Heizen)
Unit Dimensions (H×W×D; mm)	Dimensions d'unité (H×L×P; mm)	Dimensiones de la unidad (Alto × Largo × Ancho; mm)	Geräteabmessungen (H × B × T [mm])
Net Weight (kg)	Poids net (kg)	Peso neto (kg)	Nettogewicht (kg)

English	Italiano	Nederlands	Português
Model Name	Modello	Modelnaam	Nome do modelo
Power Source	Fonte di alimentazione	Voeding	Fonte de alimentação
Cooling Capacity	Capacità di raffreddamento	Koelingscapaciteit	Capacidade de arrefecimento
Heating Capacity	Capacità di riscaldamento	Verwarmingscapaciteit	Capacidade de aquecimento
Sound Pressure Level (Cooling / Heating)	Livello di pressione acustica (Raffreddamento / Riscaldamento)	Geluidsdrukniveau (Koelen / Verwarmen)	Nível da pressão do som (Arrefecimento / Aquecimento)
Sound Power Level (Cooling / Heating)	Livello di potenza acustica (Raffreddamento / Riscaldamento)	Geluidsvermogeniveau (Koelen / Verwarmen)	Nível da potência de som (Arrefecimento / Aquecimento)
Unit Dimensions (H×W×D; mm)	Dimensioni unità (A×L×P; mm)	Afmetingen van de unit (H × B × D; mm)	Dimensões da unidade (A×L×P; mm)
Net Weight (kg)	Peso netto (kg)	Nettogewicht (kg)	Peso líquido (kg)

English	Ελληνική	Български	Türkçe
Model Name	Όνομα μοντέλου	Наименование на модел	Model Adı
Power Source	Πηγή ισχύος	Захранване	Güç Kaynağı
Cooling Capacity	Δυνατότητα ψύξης	Охлаждаща мощност	Soğutma Kapasitesi
Heating Capacity	Δυνατότητα θέρμανσης	Οтоπλιitelна мощност	Isıtma Kapasitesi
Sound Pressure Level (Cooling / Heating)	Επίπεδο πίεσης ήχου (Ψύξη / Θέρμανση)	Ниво на звуково налягане (Охлаждане / Отопление)	Ses Basınç Düzeyi (Soğutma / Isıtma)
Sound Power Level (Cooling / Heating)	Επίπεδο ισχύος ήχου (Ψύξη / Θέρμανση)	Ниво на сила на звука (Охлаждане / Отопление)	Ses Güç Düzeyi (Soğutma / Isıtma)
Unit Dimensions (H×W×D; mm)	Διαστάσεις μονάδας (Υ×Π×Β, mm)	Размери на модула (В×Ш×Д, mm)	Ünite Boyutları (Y×G×D; mm)
Net Weight (kg)	Καθαρό βάρος (kg)	Нетно тегло (кг)	Net Ağırlık (kg)

**Panasonic Corporation**  
<http://www.panasonic.com>

© Panasonic Corporation 2018

Printed in Malaysia

Authorised representative in EU  
Panasonic Testing Centre  
Panasonic Marketing Europe GmbH  
Winsbergring 15, 22525 Hamburg, Germany

**ACXF55-21950**  
DC0818-0