

Mini2Plus Mini2Plus Smartphone Module



The Smartphone Module is designed to inspect electrical equipment, troubleshooting HVAC problems. Equipped with functional thermal App for smartphone, the Smartphone Module enables you to get the thermal imaging on your phone.

Key Feature

- Thermal resolution: 256 × 192 (49 152 pixels)
- NETD: < 50 mK (@ 25 °C, F#=1.0)
- Accuracy: ±2 °C (-20 °C to 100 °C) ; ±2 % (100 °C to 350 °C)
- USB Type-C Interface (Android)
- 24 g Weight

▪ Specification

Infrared Image	
IR Resolution	256 × 192 (49,152 pixels)
NETD	< 40 mK (@ 25 °C, F#=1.0)
Image Frequency	25 Hz
Detector Pitch	12 μm
Spectral Range	7.5 to 14 μm
Focal Length	6.9 mm
F-number	F1.0
Field of View (FOV)	25° × 18.8°
Min. Focus Distance	0.1 m (0.33 ft)
Focus Mode	Manual Focus
Image Display	
Color Palettes	White Hot, Black Hot, Rainbow, Ironbow, Sepia, Color, Ice Fire, Rain, Red Hot, Green Hot, Dark Blue, Combined
Image Modes	Thermal
Measurement and Analysis	
Object Temperature Range	-20°C to 350°C(-4°F to 662°F)
Accuracy	Max (±2°C/3.6°F, ±2%), for ambient temperature 15°C to 35°C (59°F to 95°F) and object temperature above 0°C (32°F)
Measurement Tools	Center Spot, Hot Spot, Cold Spot User-definable: 3 spots, and 3 rectangles.
Level and Span Mode	Auto/Manual
General	
Power Consumption	360 mW
Protection Level	IP40
Drop Test Height	1 m (3.28 ft)
Working Temperature Range	-10°C to 50°C (14°F to 122°F)
Storage Temperature Range	-20°C to 60°C (-4°F to 140°F)
Weight	Approx. 24 g (0.053 lb)
Dimension	26.6 × 26.6 × 25 mm (1.05 × 1.05 × 0.98 in)

▪ Available Model

Mini2Plus



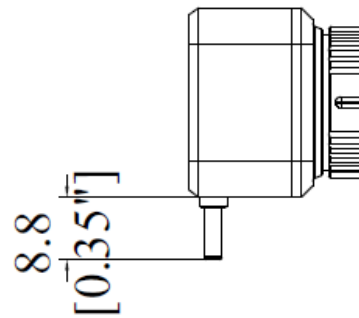
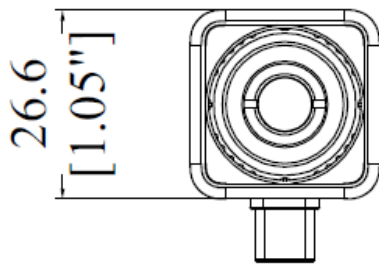
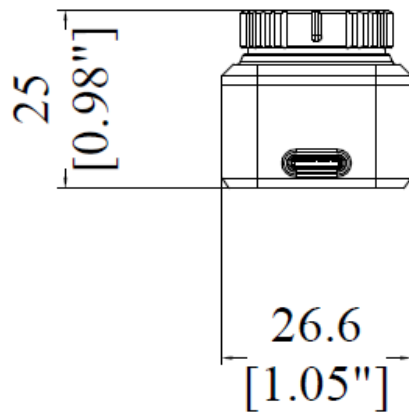



▪ Dimension



Unit: mm [inch]

COMPLIANCE NOTICE: The thermal series products might be subject to export controls in various countries or regions, including without limitation, the United States, European Union, United Kingdom and/or other member countries of the Wassenaar Arrangement. Please consult your professional legal or compliance expert or local government authorities for any necessary export license requirements if you intend to transfer, export, re-export the thermal series products between different countries.



 HIKMICRO Thermography  hikmicro_thermography  HIKMICRO Thermography  HIKMICRO  info@hikmicrotech.com  <http://hikmicrotech.com/en>

© 2023 Hangzhou HIKMICRO Sensing Technology Co., Ltd. All Rights Reserved.
Data subject to change without notice!