



**Handheld Thermal Camera
HIKMICRO E Series
User Manual**



Contact Us

Regulatory Compliance and Safety Information

Read all information and instructions in this document carefully before using the device and keep it for further reference.

For more device information and instructions, please visit our website at www.hikmicrotech.com. You can also refer to other documents (if any) accompanying the device or scan the QR code (if any) on the packaging to get more information.

©2023 Hangzhou Microimage Software Co., Ltd. All rights reserved.

About this Manual

The Manual includes instructions for using and managing the Product. Pictures, charts, images and all other information hereinafter are for description and explanation only. The information contained in the Manual is subject to change, without notice, due to firmware updates or other reasons. Please find the latest version of this Manual at the HIKMICRO website (www.hikmicrotech.com).

Please use this Manual with the guidance and assistance of professionals trained in supporting the Product.

Trademarks

 **HIKMICRO** and other HIKMICRO's trademarks and logos are the properties of HIKMICRO in various jurisdictions.

Other trademarks and logos mentioned are the properties of their respective owners.

Disclaimer

TO THE MAXIMUM EXTENT PERMITTED BY APPLICABLE LAW, THIS MANUAL AND THE PRODUCT DESCRIBED, WITH ITS HARDWARE, SOFTWARE AND FIRMWARE, ARE PROVIDED "AS IS" AND "WITH ALL FAULTS AND ERRORS". HIKMICRO MAKES NO WARRANTIES, EXPRESS OR IMPLIED, INCLUDING WITHOUT LIMITATION, MERCHANTABILITY, SATISFACTORY QUALITY, OR FITNESS FOR A PARTICULAR PURPOSE. THE USE OF THE PRODUCT BY YOU IS AT YOUR OWN RISK. IN NO EVENT WILL HIKMICRO BE LIABLE TO YOU FOR ANY SPECIAL, CONSEQUENTIAL, INCIDENTAL, OR INDIRECT DAMAGES, INCLUDING, AMONG OTHERS, DAMAGES FOR LOSS OF BUSINESS PROFITS, BUSINESS INTERRUPTION, OR LOSS OF DATA, CORRUPTION OF SYSTEMS, OR LOSS OF DOCUMENTATION, WHETHER BASED ON BREACH OF CONTRACT, TORT (INCLUDING NEGLIGENCE), PRODUCT LIABILITY, OR OTHERWISE, IN CONNECTION WITH THE USE OF THE PRODUCT, EVEN IF HIKMICRO HAS BEEN ADVISED OF THE POSSIBILITY OF SUCH DAMAGES OR LOSS.

YOU ACKNOWLEDGE THAT THE NATURE OF THE INTERNET PROVIDES FOR INHERENT SECURITY RISKS, AND HIKMICRO SHALL NOT TAKE ANY RESPONSIBILITIES FOR ABNORMAL OPERATION, PRIVACY LEAKAGE OR OTHER DAMAGES RESULTING FROM CYBER-ATTACK, HACKER ATTACK, VIRUS INFECTION, OR OTHER INTERNET SECURITY RISKS; HOWEVER, HIKMICRO WILL PROVIDE TIMELY TECHNICAL SUPPORT IF REQUIRED.

YOU AGREE TO USE THIS PRODUCT IN COMPLIANCE WITH ALL APPLICABLE LAWS, AND YOU ARE SOLELY RESPONSIBLE FOR ENSURING THAT YOUR USE CONFORMS TO THE APPLICABLE LAW. ESPECIALLY, YOU ARE RESPONSIBLE, FOR USING THIS PRODUCT IN A MANNER THAT DOES NOT INFRINGE ON THE RIGHTS OF THIRD PARTIES, INCLUDING WITHOUT LIMITATION, RIGHTS OF PUBLICITY, INTELLECTUAL PROPERTY RIGHTS, OR DATA PROTECTION AND OTHER PRIVACY RIGHTS. YOU SHALL NOT USE THIS PRODUCT FOR ANY PROHIBITED END-USES, INCLUDING THE DEVELOPMENT OR

PRODUCTION OF WEAPONS OF MASS DESTRUCTION, THE DEVELOPMENT OR PRODUCTION OF CHEMICAL OR BIOLOGICAL WEAPONS, ANY ACTIVITIES IN THE CONTEXT RELATED TO ANY NUCLEAR EXPLOSIVE OR UNSAFE NUCLEAR FUEL-CYCLE, OR IN SUPPORT OF HUMAN RIGHTS ABUSES.

IN THE EVENT OF ANY CONFLICTS BETWEEN THIS MANUAL AND THE APPLICABLE LAW, THE LATTER PREVAILS.

These clauses apply only to the products bearing the corresponding mark or information.

EU/UK Compliance Statement



This product and - if applicable - the supplied accessories too are marked with "CE" and comply therefore with the applicable harmonized European standards listed under the Directive 2014/30/EU (EMCD) and Directive 2011/65/EU (RoHS).

Note: The products with the input voltage of within 50 to 1000 VAC or 75 to 1500 VDC comply with Directive 2014/35/EU (LVD), and the rest products comply with Directive 2001/95/EC (GPSD). Please check the specific power supply information for reference.



This product and - if applicable - the supplied accessories too are marked with "UKCA" and comply therefore with the following directives:

Electromagnetic Compatibility Regulations 2016, Electrical Equipment (Safety) Regulations 2016, the Restriction of the Use of Certain Hazardous Substances in Electrical and Electronic Equipment Regulations 2012.

For the device without a supplied battery, use the battery provided by a qualified manufacturer. Refer to the product specification for detailed battery requirements

For the device without a supplied power adapter, use the power adapter provided by a qualified manufacturer. Refer to the product specification for detailed power requirements.



Directive 2012/19/EU (WEEE Directive): Products marked with this symbol cannot be disposed of as unsorted municipal waste in the European Union. For proper recycling, return this product to your local supplier upon the purchase of

equivalent new equipment, or dispose of it at designated collection points. For more information see: www.recyclethis.info.

According to the Waste Electrical and Electronic Equipment Regulations 2013: Products marked with this symbol cannot be disposed of as unsorted municipal waste in the United Kingdom. For proper recycling, return this product to your local supplier upon the purchase of equivalent new equipment, or dispose of it at designated collection points. For more information see: www.recyclethis.info.



Directive 2006/66/EC and its amendment 2013/56/EU (Battery Directive): This product contains a battery that cannot be disposed of as unsorted municipal waste in the

European Union. See the product documentation for

specific battery information. The battery is marked with this symbol, which may include lettering to indicate cadmium (Cd), lead (Pb), or mercury (Hg). For proper recycling, return the battery to your supplier or to a designated collection point. For more information see: www.recyclethis.info.

According to the Batteries and Accumulators (Placing on the Market) Regulations 2008 and the Waste Batteries and Accumulators Regulations 2009: This product contains a battery that cannot be disposed of as unsorted municipal waste in the United Kingdom. See the product documentation for specific battery information. The battery is marked with this symbol, which may include lettering to indicate cadmium (Cd), lead (Pb), or mercury (Hg). For proper recycling, return the battery to your supplier or to a designated collection point. For more information see: www.recyclethis.info.

Industry Canada ICES-003 Compliance

This device meets the CAN ICES-003 (B)/NMB-003 (B) standards requirements.



Cet appareil répond aux exigences des normes CAN ICES-003 (B)/NMB-003 (B).

KC

B 급 기기: 이 기기는 가정용(B 급) 전자파적합기기로서 주로 가정에서 사용하는 것을 목적으로 하며, 모든 지역에서 사용할 수 있습니다.

Safety Instruction

The symbols that may be found in this document are defined as follows.

| Symbol | Description |
|---|---|
|  Danger | Indicates a hazardous situation which, if not avoided, will or could result in death or serious injury. |
|  Caution | Indicates a potentially hazardous situation which, if not avoided, could result in equipment damage, data loss, performance degradation, or unexpected results. |
|  Note | Provides additional information to emphasize or supplement important points of the main text. |

These instructions are intended to ensure that user can use the product correctly to avoid danger or property loss.

Laws and Regulations

- Use of the product must be in strict compliance with the local electrical safety regulations.

Transportation

- Keep the device in original or similar packaging while transporting it.
- Keep all wrappers after unpacking them for future use. In case of any failure occurred, you need to return the device to the factory with the original wrapper. Transportation without the original wrapper may result in damage on the device and the company shall not take any responsibilities.
- Do not drop the product or subject it to physical shock. Keep the device away from magnetic interference.

Power Supply

- The input voltage should meet the Limited Power Source (5 VDC, 2 A) according to the IEC61010-1 standard. Please refer to technical specifications for detailed information.
- Make sure the plug is properly connected to the power socket.
- DO NOT connect multiple devices to one power adapter, to avoid over-heating or fire hazards caused by overload.
- Use the power adapter provided by a qualified manufacturer. Refer to the product specification for detailed power requirements.

Battery

- The built-in battery cannot be dismantled. Please contact the manufacture for repair if necessary. The battery may explode if it is replaced by an incorrect type. Replace with the same or equivalent type only. Dispose of used batteries in conformance with the instructions provided by the battery manufacturer.
- For long-term storage of the battery, make sure it is fully charged every half year to ensure the battery quality. Otherwise, damage may occur.
- Make sure the plug is properly connected to the power socket.
- When the device is powered off and the battery is full, the time settings can be kept for 60 days.
- The standard adapter power supply is 5 V.
- The battery is certified by UL2054.

Maintenance

- If the product does not work properly, please contact your dealer or the nearest service center. We shall not assume any responsibility for problems caused by unauthorized repair or maintenance.
- Wipe the device gently with a clean cloth and a small quantity of ethanol, if necessary.
- If the equipment is used in a manner not specified by the manufacturer, the protection provided by the device may be impaired.
- Your camera will periodically perform a self-calibration to optimize image quality and measurement accuracy. In this process the image will pause briefly and you will hear a “click” as a shutter moves in front of the detector. The self-calibration will be more frequent during the startup or in very cold or hot environments. This is a normal part of operation to ensure optimum performance for your camera.

Calibration Service

We recommend you send the device back for calibration once a year, and please contact the local dealer for the information on maintenance points. For more detailed calibration services, please visit

<https://www.hikmicrotech.com/en/support/calibration-service.html>.

Technical support

<https://www.hikmicrotech.com/en/contact-us.html> portal will help you as a HIKMICRO customer to get the most out of your HIKMICRO products. The portal gives you access to our support team, software and documentation, service contacts, etc.

Using Environment

- Make sure the running environment meets the requirement of the device. The operating temperature shall be -10 °C to 50 °C (14 °F to 122 °F), and humidity shall be 95% or less.
- Place the device in a dry and well-ventilated environment.
- DO NOT expose the device to high electromagnetic

radiation or dusty environments.

- DO NOT aim the lens at the sun or any other bright light.
- When any laser equipment is in use, make sure that the device lens is not exposed to the laser beam, or it may burn out.
- The device is suitable for indoor and outdoor uses, but do not expose it in wet conditions.
- The level of protection is IP 54.
- The pollution degree is 2.

Emergency

If smoke, odor, or noise arises from the device, immediately turn off the power, unplug the power cable, and contact the service center.

Laser Light Supplement Warning



Warning: The laser radiation emitted from the device can cause eye injuries, burning of skin or inflammable substances. Prevent eyes from

direct laser. Before enabling the Light Supplement function, make sure no human or inflammable substances are in front of the laser lens. The wave length is 650 nm, and the power is less than 1 mW. The laser meets the IEC60825-1:2014 standard.

Laser maintenance: It is not necessary to maintain the laser regularly. If the laser does not work, the laser assembly needs to be replaced in the factory under warranty. Keep the device power off when replacing laser assembly. Caution-Use of controls or adjustments or performance of procedures other than those specified herein may result in hazardous radiation exposure.

Manufacture Address:

Room 313, Unit B, Building 2, 399 Danfeng Road, Xixing Subdistrict, Binjiang District, Hangzhou, Zhejiang 310052, China

Hangzhou Microimage Software Co., Ltd.

COMPLIANCE NOTICE: The thermal series products might be subject to export controls in various countries or regions, including without limitation, the United States, European Union, United Kingdom and/or other member countries of the Wassenaar Arrangement. Please consult your professional legal or compliance expert or local government authorities for any necessary export license requirements if you intend to transfer, export, re-export the thermal series products between different countries.

CONTENTS

| | | |
|----------|--|-----------|
| 1 | Introduction | 1 |
| 1.1 | Packing List..... | 1 |
| 1.2 | Product Introduction..... | 1 |
| 1.3 | Main Function | 1 |
| 2 | Appearance | 2 |
| 2.1 | Dimensions | 2 |
| 2.2 | Components | 2 |
| 3 | Preparation | 4 |
| 3.1 | Charge Device..... | 4 |
| 3.2 | Power On/Off..... | 4 |
| 3.3 | Live View | 5 |
| 4 | Display Settings..... | 5 |
| 4.1 | Set Image Mode | 5 |
| 4.2 | Set Palettes | 6 |
| 4.3 | Set Level & Span..... | 6 |
| 4.4 | Display OSD Info..... | 7 |
| 5 | Temperature Measurement | 7 |
| 5.1 | Set Measurement Parameters | 7 |
| 5.2 | Set Image Measurement..... | 8 |
| 5.3 | Enhance High-Temperature Target..... | 8 |
| 5.4 | Set Temperature Alarm | 9 |
| 6 | Capture Snapshots | 9 |
| 6.1 | Capture One Image | 9 |
| 6.2 | View Snapshots | 10 |
| 6.3 | Export Snapshots | 10 |
| 7 | Cast Screen..... | 10 |
| 8 | Maintenance | 11 |
| 8.1 | View Device Information | 11 |
| 8.2 | Set Time and Date | 11 |
| 8.3 | Format Storage..... | 11 |
| 8.4 | Upgrade..... | 11 |
| 8.5 | Restore Device | 12 |
| 9 | Appendix..... | 12 |
| 9.1 | Common Material Emissivity Reference | 12 |
| 9.2 | Frequently Asked Questions (FAQ) | 12 |

1 Introduction

1.1 Packing List



Handheld Thermal Camera (× 1)

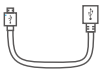

USB Cable (× 1)



Wrist Strap
(× 1)



QSG (× 1)



Calibration
Certificate (× 1)

1.2 Product Introduction

The handheld thermal camera is a camera with thermal and optical images. The built-in high-sensitivity IR detector and high-performance sensor detects the temperature change and measures the real-time temperature.

The handheld thermal camera is based on the thermal technology, specially designed for the needs of temperature measuring applications. People can quickly troubleshoot faults on-site.

1.3 Main Function

Temperature measurement

Device detects the real-time temperature, and display it on the screen.

Alarm

Device outputs audible and visual alarm when the target's temperature is higher than the threshold value.

SuperIR

Device supports superior to increase the image quality.

Client Software Connection

PC: You can download HIKMICRO Analyzer (<https://www.hikmicrotech.com/en/industrial-products/hikmicro-analyzer-software.html>) to analyze pictures offline professionally, and generate a custom format report on your PC. You can cast the real-time live view of the device to your PC through the UVC alarm client.





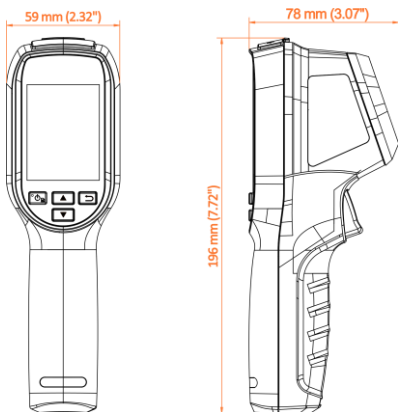

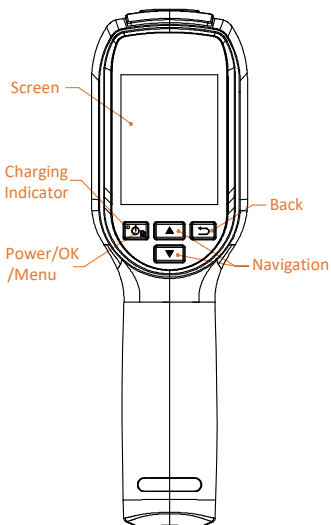

2 Appearance

2.1 Dimensions



2.2 Components



| Button | Function |
|--|--|
|  | Hold: Power On/Off Press: Display menu or confirm operation |
|  | Exit the menu or return to previous menu. |
|   | In menu mode: Press  and  to select parameters. In live view mode: Press  to switch image modes (only supported by certain models). Press  to switch palettes. |

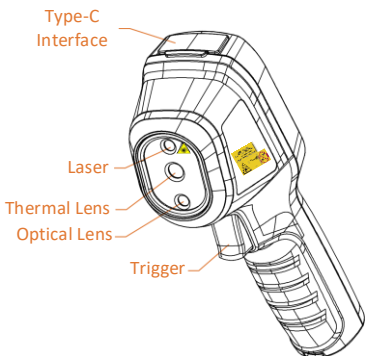

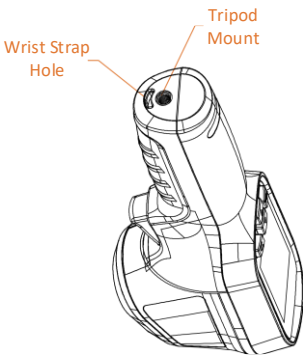

| Component | Function |
|--------------------|--|
| Charging Indicator | Solid Red: Charging. Solid Green: Fully charged. |
| Type-C Interface | Charge the battery or export snapshots. |
| Trigger | In live view: <ul style="list-style-type: none"> ● Press: Capture snapshots. ● Hold: Locate the target with laser light, and release to capture snapshots. In menu mode, press the trigger to go back to live view. |
| Tripod Mount | Connect to UNC 1/4"-20 tripod. |

 **Note**

- The appearance and button functions vary according to different models.
- The optical lens is only supported by certain models. Please refer to the actual device or datasheet.
- The warning sign is beside the laser and on the left side of the device.



Warning:

The laser radiation emitted from the device can cause eye injuries, burning of skin or inflammable substances. Prevent eyes from direct laser. Before enabling the Light Supplement function, make sure no human or inflammable substances are in front of the laser lens. The wave length is 650 nm, and the power is less than 1 mW. The laser meets the IEC60825-1:2014 standard.

3 Preparation

3.1 Charge Device

Steps:

- 1 Lift the type-C interface cover.
- 2 Connect the device to power supply using the type-C cable to charge the device.

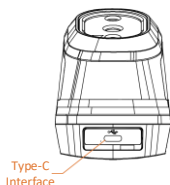

Note

The device is equipped with the built-in battery. For the first charge, charge the device for more than 3 hours when the device is turned on.

3.2 Power On/Off

Power On

Remove the lens cover, and hold  for over six seconds to turn on the device. You can observe the target when the interface of the device is stable.

Power Off

When the device is on, hold  for six seconds to power off the device.

Set Auto Power-off Duration

In the live view interface, press  and go to **More Settings** → **Auto Power-off** to set the automatic shutdown time for device as required.

3.3 Live View

The live view interface of different models may vary. Take the actual product for reference.

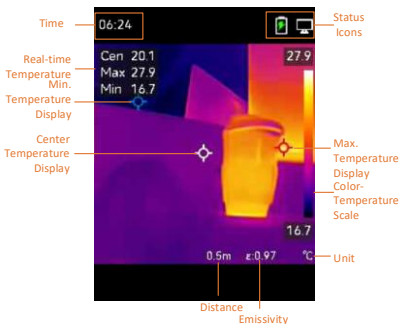



4 Display Settings

4.1 Set Image Mode

You can set image modes of the device. **Image Mode** is only supported by certain models. Please refer to the actual device or the datasheet.

Steps:



- 1 Select an image mode by the following ways:
 - Go to **Settings** → **Image Settings** → **Image Mode**, and select a preferred image mode.
 - Press  in live view to switch image modes.
 - Thermal: Display the thermal image only.
 - Fusion: Fuse the optical image with the thermal image. The fused image with clear edge is displayed in this mode.
 - Visual: Display the visual image only.
- 2 **Optional:** When selecting the fusion mode, you need to select the distance in **Image Settings** → **Parallax Correction** according to the distance to the target, so as to better overlap the thermal and optical images.
- 3 Press  to save and exit.

 **Note**

Your camera will periodically perform a self-calibration to optimize image quality and measurement accuracy. In this process the image will pause briefly and you will hear a “click” as a shutter moves in front of the detector. The self-calibration will be more frequent during the startup or in very cold or hot environments. This is a normal part of operation to ensure optimum performance for your camera.

4.2 Set Palettes











The palettes allow you to select the desired colors. You can switch palettes by the following ways:

- Go to **Settings** → **Palettes** to select a preferred palette, and press  to save and exit.
- Press  in live view to switch palettes.

4.3 Set Level & Span

Set a display temperature range and palette only works for targets within the temperature range. You can get better image contrast by adjusting the level & span parameters.

Steps:

- 1 In the live view interface, press  to show the menu.
- 2 Press  / , and select **Level & Span**.
- 3 Select **Setting Mode**, and press  to switch auto and manual adjustment.
 - In **Auto** mode, the device adjusts display temperature range automatically.
 - In **Manual** mode, select **Parameters** to enter the setting interface. Press  to lock or unlock the max. temperature and min. temperature, and press  /  to adjust unlocked value. Or, unlock the max. temperature and min. temperature, and press  /  to increase or decrease the individual values while remaining the same temperature range.
- 4 Press  to save and exit.

4.4 Display OSD Info

Go to **Settings** → **Display Settings** to enable the information on-screen display.

Parameters

Temperature measurement parameters such as emissivity and distance.

Brand Logo

The brand logo is a manufacturer logo displayed on the lower left corner of the screen. You can turn it off if not needed.









5 Temperature Measurement

The temperature measurement function provides the real-time temperature of the scene. The temperature information is displayed on the left top of your screen. The function is enabled by default.

5.1 Set Measurement Parameters

You can set temperature measurement parameters to improve the accuracy of temperature measurement.





Steps:

- 1 In the live view interface, press  to show the menu.
- 2 Press / to select desired parameters.
- 3 Press  to go to the setting interface.
 - **Emissivity:** Enable **Custom**, and select **Emissivity** to set the emissivity of the target as the effectiveness in emitting energy as thermal radiation by pressing /. Or you can select a preset emissivity.
 - **Distance:** Set the distance between the target and the device.
 - **Unit:** Go to **More Settings** → **Unit**, and press  to set the temperature unit.
 - **Temperature Range:** Select a temperature range or select **Auto Switch**. The device can detect the temperature and switch temperature range automatically in **Auto Switch** mode.
- 4 Press  to save and exit.

5.2 Set Image Measurement

Device measures the temperature of the whole scene and can be managed to display the center, hot, and cold spot in the scene.

Steps:

- 1 In the live view interface, press  to show the menu.
- 2 Press / to select **Display Settings**.
- 3 Select the desired spots to show their temperatures, and press  to enable them.
 - **Hot:** Display the hot spot in the scene and show the max. temperature.
 - **Cold:** Display the cold spot in the scene and show the min. temperature.

- **Center:** Display the center spot in the scene and show the center temperature.

4 Press  to save and exit.





Result:

The device shows the real-time temperature on the upper left side of live view interface.

5.3 Enhance High-Temperature Target

In target enhancement function, when the target's temperature is higher than the set value, the target will become red.





Steps:

- 1 You can enable target enhancement function by the following ways:
 - Go to **Settings** → **Palettes**, and select **Above Alarm**.
 - Press  in live view to switch the palette to **Above Alarm**.
- 2 Go to **Settings** → **Palettes** → **Temperature**, and press / to configure the enhancement temperature threshold. When the temperature of target is higher than the set value, the target will be red in live view.
- 3 Press  to save and exit.

5.4 Set Temperature Alarm

Set the alarm rules and the device will alarm when the temperature triggers the rule.

Steps:

- 1 In the live view interface, press  to show the menu.
- 2 Press /, and select **Alarm**.
- 3 Press  to enable the function.
- 4 Select **Measurement** to set the alarm rule. Select **Alarm Threshold** to set the threshold temperature. When the target's temperature is higher or lower than the threshold value, the device will output alarm.
- 5 Press  to save and exit.

6 Capture Snapshots

6.1 Capture One Image

You can capture snapshots in live view. The snapshot will be automatically saved in the albums.

Steps:

- 1 In the live view interface, you can capture snapshots by the following ways.
 - Press the trigger in live view to capture snapshots.
 - Hold the trigger in live view to locate the target with laser light, and release the trigger to capture snapshots.

Note











- Go to **More Settings** → **Laser** to turn on/off laser light.
 - You cannot capture snapshots when the device is connected with PC.
- 2 **Optional:** If the thermal images are exported and viewed on a high resolution screen, enable **SuperIR** in the menu before capturing. Resolution of captured images with **SuperIR** is 4 times higher the original one.
 - 3 **Optional:** If a visual image is needed to be saved separately, enable **Save Visual Image** (only supported by the models with optical lens).

What to do next:

You can view and manage the snapshots in the album, and export them to PC.

6.2 View Snapshots

Steps:

- 1 In the live view interface, press  to show the menu.
- 2 Press  /  to select **Albums**, and press  to enter the album.
- 3 Press  /  to select the picture, and press  to view it.
- 4 **Optional:** Press  to delete picture in picture view interface. Press  /  to switch the picture.
- 5 Press  to exit.

6.3 Export Snapshots

Purpose:

Connect the device to your PC with Type-C cable, and then you can export the captured snapshots.

Steps:

- 1 Lift the type-C interface cover.
- 2 Connect the camera to your PC with Type-C cable and open the detected disk.

- 3 Copy and paste the snapshots to PC and view the files.
- 4 Disconnect the device from your PC.

Note

- For the first connection, the driver will be installed automatically.
- DO NOT disconnect the Type-C cable from PC during drive installation, or it may cause damage to the device.



7 Cast Screen

The device supports casting screen to PC by UVC protocol-based client software or player. You can connect the device to your PC via a type-C cable, and cast the real-time live view of the device to your PC through the UVC client software.

Before You Start

- Connect the device and PC with supplied Type-C cable.
- Download the UVC client software from and install the client on your PC. Refer to the user manual of the Client for detailed operation.

Steps:

- 1 In the live view interface, press  and go to **More Settings → USB Cast Screen**.
- 2 Press  to enable the function.
- 3 Open the Client on your PC, and you can view the live view and operation of the device.

8 Maintenance

8.1 View Device Information



In the live view interface, press  and go to **More Settings → About** to view the device information.

8.2 Set Time and Date

In the live view interface, press  and go to **More Settings → Time and Date** to set the information.

8.3 Format Storage

Steps:

- 1 In the live view interface, press  and go to **More Settings → Format Storage**.
- 2 Press  and select **OK** to start formatting storage.

Note

Format storage before first use.

8.4 Upgrade

Before You Start:

Download the upgrade file from the official website first.

Steps:

- 1 Connect the device to your PC with Type-C cable and open the detected disk.
- 2 Copy the upgrade file and replace it to the root directory of the device.
- 3 Disconnect the device from your PC.
- 4 Reboot the device and then it will upgrade automatically. The upgrading process will be displayed in the main interface.

Note

After the upgrading, the device automatically reboot. You can view the current version in **More Settings → About**.

8.5 Restore Device

In the live view interface, press  and go to **More Settings → Restore Device** to initialize the device and restore default settings.

9 Appendix

9.1 Common Material Emissivity Reference

| Material | Emissivity |
|-----------------|------------|
| Human Skin | 0.98 |
| PCB | 0.91 |
| Cement Concrete | 0.95 |
| Ceramics | 0.92 |
| Rubber | 0.95 |
| Paint | 0.93 |
| Wood | 0.85 |
| Asphalt | 0.96 |
| Brick | 0.95 |
| Sand | 0.90 |
| Soil | 0.92 |
| Cotton | 0.98 |
| Cardboard | 0.90 |
| White Paper | 0.90 |
| Water | 0.96 |

9.2 Frequently Asked Questions (FAQ)

Q: The charge indicator flashes red.

A: Examine the items below.

1. Examine whether the device is charged with the standard power adapter.
2. Make sure the environment temperature is above 0°C (32°F).

Q: Capturing fails.

A: Examine the items below:

1. Whether the device is connected to your PC and the capture function is unavailable.
2. Whether the storage space is full.
3. Whether the device is low-battery.

Q: The PC cannot identify the camera.

A: Examine whether the device is connected to your PC with standard Type-C cable.

Q: The camera cannot be operated or no responding.

A: Hold  to reboot the camera.



HIKMICRO

See the World in a New Way

Facebook: [HIKMICRO Thermography](#)

Instagram: [hikmicro_thermography](#)

E-mail: support@hikmicrotech.com

Website: www.hikmicrotech.com

LinkedIn: [HIKMICRO](#)

YouTube: [HIKMICRO Thermography](#)

UD32714B